



This document is applicable to FedEx Express.

How to Pack

Whether you're looking for general guidelines for packing day-to-day shipments or specific guidelines for shipping specialty items, you'll find it all here in our series of comprehensive packaging guides. Click the one you want. Print just what you need.



Click the guide you want.

General Packaging Guidelines	3
Packaging Perishable Shipments	12
Packaging Flowers and Plants	19
Packaging Computer Shipments	23
Packaging Clinical Samples	29
Packaging UN 3373 Shipments	33
Automotive and Mechanical Parts Shipments	37
Packaging Battery Shipments	45

General Packaging Guidelines

At FedEx, we know proper packaging can help ensure that your shipments arrive safely. To assist you, we provide these general packaging guidelines — from measuring and weighing your package, to packing methods, sealing, and labeling instructions, and guidelines for restricted shipments.

Shipment Size and Weight Restrictions

- With FedEx Express international services, you can ship packages up to 68kg (150 lbs.), up to 274cm (108") in length and 330cm (130") in length and girth. An additional handling surcharge - dimension may be applied if a shipment containing packages that measures greater than 121 cm along its longest side; measures greater than 76 cm along its second-longest side; or measures greater than 266 cm in length and girth. An oversize charge may be applied if a shipment contains packages that exceed 243 cm in length, or 330 cm in length and girth. If the oversize charge is applied to a shipment, the additional handling surcharge - dimension will not apply. Please visit [fedex.com](https://www.fedex.com) for details for details of applicable surcharges that may apply to your shipment.
- With FedEx Express® Freight Services, you can ship individual skids of 68kg (150 lbs.) or more. Skids exceeding 997kg (2,200 lbs.) in weight or exceeding 178cm (70") in height, 302cm (119") in length, or 203cm (80") in width require prior approval. An additional handling surcharge - freight may be applied for freight handling unit with longest side greater than 157 cm. Please visit [fedex.com](https://www.fedex.com) for details of applicable surcharges that may apply to your shipment.
- Yellow and black safety heavyweight labels will be placed by FedEx over the diagonal corners of your package if it weighs more than 32 kg (70 lbs.). An additional handling surcharge -weight may be applied for package with actual weight greater than 31kg.

Measuring Length and Girth

The length and girth formula is simple. Here's what you do:

- Measure the length, height, and width of the package.
- Length and girth equals length plus twice the width and twice the height.

Length is the longest side of the package or object.

Length and Girth

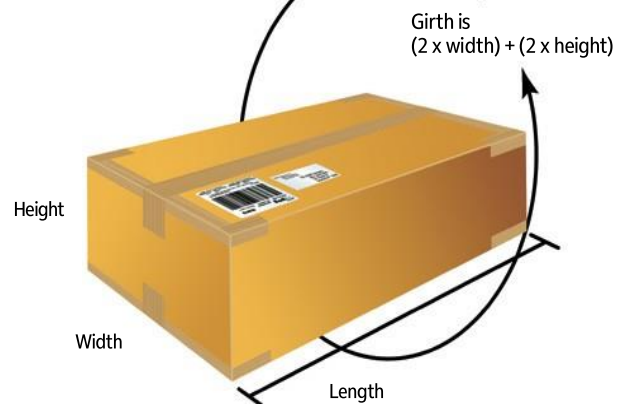

Calculating Dimensional (DIM) Weight

Dimensional weight applies when the package is relatively light compared with its volume. If the dimensional weight exceeds the actual weight, charges based on the dimensional weight will be assessed. To calculate it:

- Multiply length by width by height in centimeters or in inches.
- Divide by 5,000 for centimeters or by 305 for inches.
- Compare the dimensional weight and actual weight. Your chargeable weight is the greater of the actual weight or the dimensional weight.

General Packaging Guidelines

- Use FedEx Express packaging for FedEx Express package shipments only; any other use is prohibited.
- You may use your own packaging if boxes are sturdy and undamaged with all flaps intact.
- Chipboard boxes, such as gift or shoe boxes, must be packed into a corrugated fiberboard outer box.
- Use double-wall boxes for heavier items.

- Ensure your package is fully encased in an outer shipping container or packaging. The outer shipping container or packaging should be made of corrugated fiberboard materials and is flat on each side. Other rigid containers such as plastic cases, wooden crates, and metal totes can be used, but such packaging may incur additional handling surcharges - packaging.
- For FedEx Express shipments, go to [fedex.com](https://www.fedex.com) to order complimentary packaging.
- Place small packages inside a larger outer corrugated fiberboard box. For express shipments smaller than 7" x 4" x 2" (18cm x 10cm x 5cm), use a FedEx Express packaging option.
- Double-box fragile items with 3" (8cm) of cushioning in and around the smaller box.
- Wrap items individually with cushioning material and center them in boxes away from other items and away from the sides, corners, top, and bottom of the box.
- Position bottles that contain liquids upright. Use an inner seal and perforated breakaway cap. The inner packaging must be able to contain leaks.
- Place items that might be damaged by normal handling, such as soiling, marking, or application of adhesive labels, in a protective outer box.
- For odd- or irregular-shaped items, at a minimum you should wrap and tape all sharp edges or protrusions.
- Enclose an extra label, business card, or letterhead with the shipper's address and phone number and the recipient's address and phone number inside the package before sealing it.
- Remove all old address labels from reused boxes before shipping, and make sure there are no holes, tears, or corner dents in the outer box.
- Rolled goods should be placed inside a FedEx tube, triangular tube, corrugated fiberboard box, or crating method. An additional handling surcharge can apply if you use the crating method.

General Packing Methods

Follow these general guidelines for the two most popular packing methods, plus recommendations for odd- or irregular-shaped shipments.

Single-Box Packing Method

- Ship nonfragile products like soft goods inside a sturdy outer box.
- Use fillers like crumpled newspaper, loosefill peanuts, or air-cellular cushioning material such as Bubble Wrap® to fill void spaces and prevent movement of goods *inside* the box during shipping.
- Place goods that might be affected by dirt, water, or wet conditions inside a plastic bag.
- Consolidate small parts or spillable granular products in a strong sealed container, such as a burlap or sift-proof plastic bag, then package in a sturdy outer box.
- Use the H taping method for [sealing your package](#).

Single-Box with Wrapped Item

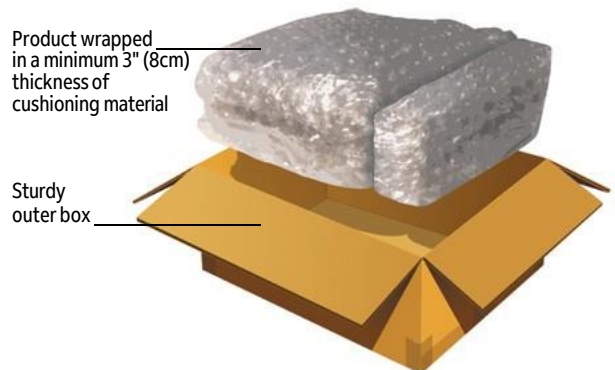

Single-Box Filled with Loosefill Peanuts

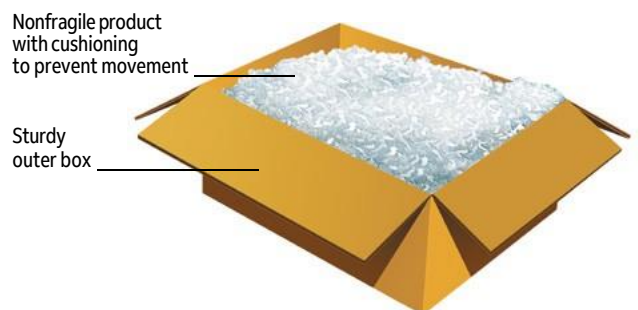

Box-in-Box Packing Method

- Wrap product(s) individually with at least 2" (5cm) thick-ness of air-cellular cushioning or foam material to fit snugly inside a corrugated fiberboard box.
- Restrict product movement *inside* the box using filler like crumpled newspaper, loosefill peanuts, or other cushioning material.
- Close and tape the inner box using the H taping method. This will help prevent accidental opening.
- Use a second box that is at least 6" (15cm) longer, wider, and deeper than the inner box.
- Choose the wrap or fill method to cushion the inner box inside the larger sturdy outer corrugated fiberboard box.
- Ship fragile products individually, wrapping them in a minimum 3" (8cm) thickness of air-cellular cushioning material.
- Wrap the inner box with 3" (8cm) thickness of air-cellular cushioning material or use at least 3" (8cm) of loosefill peanuts or other cushioning material to fill the spaces between the inner box and outer box on the top, bottom, and all sides.
- Fill any void spaces with more cushioning material.
- Use the H taping method for sealing your package.

Box-in-Box with Loosefill Peanuts

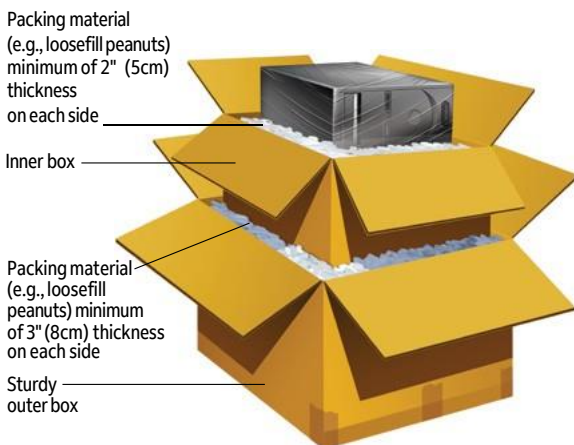

Box-in-Box with Air-Cellular Cushioning

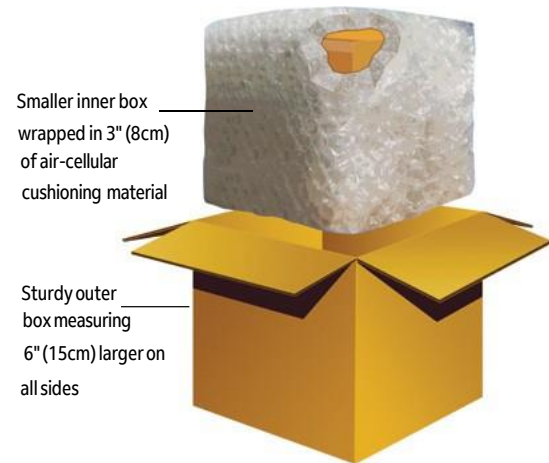

Multiple piece shipments

Explore your options for shipping multiple packages in one shipment. These tips will help when you want all your packages to arrive at the same time and place.

- Use the overbox method. Place all your packages into one large, corrugated fiberboard box.
- Make sure your large, corrugated fiberboard box meets our size and weight restrictions.
- Ship it with FedEx Freight. If your packages combined weight totals over 68kg (150 lbs.) give FedEx Freight a try. For more information on FedEx Freight visit fedex.com

Sealing Your Package

- Use pressure-sensitive plastic tape, water-activated paper tape (minimum 60-lbs. (27kg) grade), or water-activated reinforced tape that is at least 2" (5cm) wide.
- Apply tape evenly across flaps and seams to both the top and bottom of the outer box. Use the H taping method.
- Do not use cellophane tape, duct tape, masking tape, string, or rope to seal packages. In addition, do not wrap the outer box in shrink wrap, stretch wrap, or Bubble Wrap.

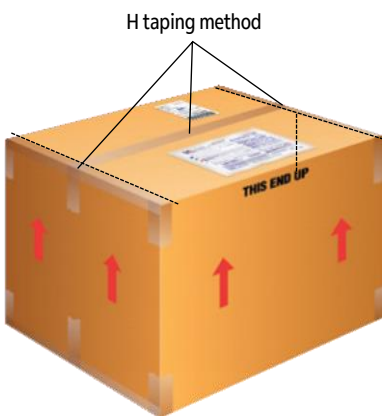

- Shrink wrap should not be used around corrugated fiberboard boxes, corrugated plastic boxes, or other transit cases made of plastic, metal, or wood. Stretch wrap and Bubble Wrap are both prohibited from use on the exterior of small parcel packages.
- The package should not be bound with metal, plastic, or cloth banding. It should however be properly sealed using the H taping method. Packages with banding will be subject to an additional handling surcharge – packaging.

Addressing and Labeling Your Package

- Place delivery information inside and outside the package. Include an address for your recipient and yourself.
- Remove or cross out any old address labels on the outer box.
- Shipping labels and packing slips should be applied facing the same direction on the same side of the package.
- Avoid wrapping labels around the corner or directly on the edge or seam of the package.
- Place shipping labels on the package's largest surface. While we cannot ensure compliance with markings such as "Up" arrows or "This End Up," properly placing the shipping label increases your chance for the preferred orientation.
- To avoid scanning issues, do not apply tape, wrappings, or other coverings over the shipping label. The coverings make the barcode unreadable.
- Use tie-on tags on transit cases (including tradeshow display cases), golf bags, skis, and luggage. Packaging made of non-corrugated fiberboard materials may be subject to additional handling surcharges-packaging.

Use applicable routing label, airbill, or address label



Packaging Specialty Shipments

Some shipments require detailed instructions for proper packaging to ensure intact delivery to your destination. The following page has recommendations for items that don't require such specific guidelines.

General Guidelines for Unique Items

- **Artwork.** Apply masking tape in a crisscross pattern on the glass surface to prevent glass from splintering. FedEx Office has a selection of framed-art boxes for purchase. Or let the pros do the packing for you.
- **Photos and Posterboard.** Tape flat items onto a rigid material like plywood, plastic, or layers of corrugated fiberboard padding; as an alternative, place printed material between two corrugated pads and tape both pads together at all seams.
- **Undeveloped Film.** Prominently mark packages containing undeveloped film. Special labels are available.
- **Stringed Musical Instruments.** Loosen the tension on the strings to remove the stress on the neck of the instrument. Place the instrument in a strong box with cushioning materials to prevent damage.
- **Printed Matter.** Bundle printed material together to prevent shifting. Cushion sufficiently before packing into a double-walled corrugated outer box.
- **Rolled Goods.** Tightly wrap rolled goods using several layers of heavy-duty plastic film and wrap with plastic packing tape. Once wrapped, place the rolled good into a FedEx tube or corrugated fiberboard box. FedEx cannot assume liability for damage due to inadequate protection.



- **Tires and Wheels:** Cushion the bottom of the box with 3" (8cm) of bubble packaging. Place the tire inside the box. Cushion the sides and top of the box with 8cm of the bubble packaging or other cushioning material. Tape the box and apply shipping label on top of the box.
- **Wine:** Two-piece molded polystyrene inner packaging shipped with flute double-wall corrugated outer container or packaging. All closure flaps must be sealed securely, top and bottom, with pressure-sensitive tape.

Banker Box, Storage Box, Archive Box, Document Box, Copy Paper Box

These boxes are designed for palletized transport and storage, not individual transport. However, such boxes can be shipped successfully with proper reinforcement and within certain parameters. FedEx will accept such shipments, but the following criteria are strongly recommended:

- The total weight of the shipment should not exceed 30 lbs. (14kg).
- Use only new, undamaged boxes for shipping. Used boxes are more likely to result in loss of or damage to the contents.
- Secure the box with 2"- to 3"- (5cm to 8cm) wide plastic pressure-sensitive shipping tape around the length, width, and perimeter of the box in two places. Upon completion the tape should resemble a "tic-tac-toe" pattern on all sides of the box.
- If the box is not completely full of product, fill all void areas with packing material, e.g., Bubble Wrap, crumpled kraft paper (not newspaper), or loosefill peanuts.
- For identity purposes, apply a shipping label to both the lid and the side of the base for two-piece box shipments.
- If the above recommendations cannot be satisfied, place the material in a new corrugated fiberboard box or use a box-in-a-box of proper size and strength for the weight of product being shipped. Additional handling surcharges may apply.

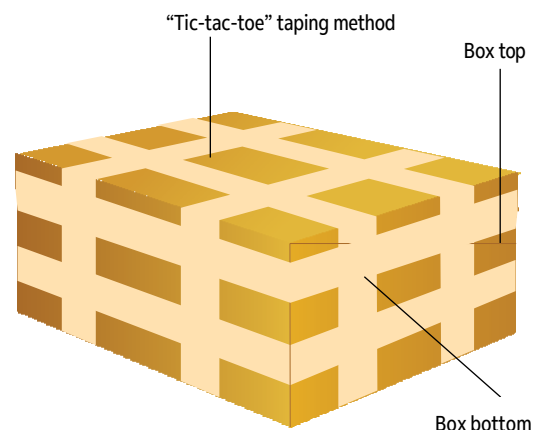

Packaging Freight Shipments

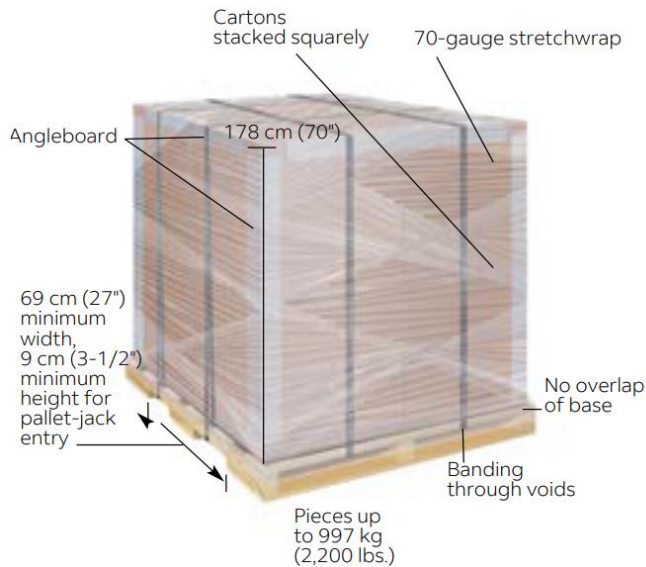

Shipments that are “freight” (as defined by the applicable FedEx Standard Conditions of Carriage) must be packaged accordingly.

You must package your freight shipments to allow for stacking of other freight shipments on top of your shipment. A non-stackable surcharge may be applied if your shipment is non-stackable. Make sure your freight shipments are banded and stretch-wrapped to the pallet, with the bands running in both directions. (Pallet loads secured with only stretch wrap are not acceptable.)

Avoid corrugated or fiberboard pallets. You must secure all freight shipments weighing 68 kg (150lbs.) or more on a forkliftable base, compatible with pallet-jack usage. The minimum specifications for a typical base for forklift or pallet-jack configuration are illustrated above.

To lessen the possibility of damage or delay to your cargo, make sure that all single-piece cargo greater than 68 kg (150 lbs.) is banded on all sides with heavy-duty metal or break-resistant plastic banding.

If your cargo is a single piece contained within a hardened container (plywood, metal) and is greater than 68 kg, it does not require banding if exterior locks or clamps are used. (Glue, nails, or screws are not sufficient.)

Pallet



- The use of pallets is an ideal approach to help reduce the risk of damage to your shipment. The design and materials used in building a pallet itself must consider the weight of the items to be carried in the container.
- Transit pallets should be shrink wrapped and strapped.

Constructing a pallet



Check all pallets before use for any signs of wear and tear.

The proper construction of a pallet is crucial as this will have a significant impact on the integrity of the shipment:

- The correct method to ensure stability and strength is to stack boxes in columns. This involves placing boxes directly on top of each other to form a 'cube' shape, making sure the load has a flat surface at the top. Please check that **the boxes** fit correctly on the pallet and **do not overhang the edge of the pallet**.
- Boxes should only be stacked overlapping each other, known as the '**bricklayer**' method if the individual cartons and their contents form a rigid unit.
- Please note when palletizing boxes, if a box is only partially filled it can easily become crushed under the weight of other parcels on the pallet. Therefore, any empty space in a box should be filled with suitable cushioning materials i.e. foam, corrugated cardboard etc.
- **Avoid building 'pyramid' shape pallets** as the lack of a level surface weakens the overall packaging and may expose the contents to damage from other shipments.

Strapping and shrink-wrapping



Most damage caused to palletized boxes during transit is due to the shipment not being correctly stacked, bundled, or secured.

We only accept palletized shipments which are securely and safely strapped, shrink-wrapped, and banded. :

- **Top and bottom load protector pads help to reduce damage** to the top and bottom of the shipment. Corner or edge boards which should run the full length of the pallet help to stabilize the load and protect the box edges at each corner of the pallet.
- **Strapping with two straps from both sides, 4 in total, is generally used to secure the bundled load to the pallet.** Strapping and/or wrapping can be applied around several decking rows for additional stability. There are various forms of strapping including steel, polypropylene, nylon, or polyester. Heavy duty strapping such as steel is preferred for heavy loads as it does not stretch.
- Shrink-wrapping is critical for bundling the load and securing the items to the pallet. It is a packaging technique which involves wrapping thin, stretchable plastic film, tightly around the load.

The shrink-wrap should be tucked between the pallet and the bottom row of boxes or tied to the bottom of the pallet. The wrap should be spiraled around the boxes in an upward direction making sure the film overlaps. At the top of the load, stretch the film diagonally over the corners and then spiral back down to the bottom leaving a slight overlap at the pallet base. As a minimum, there should be 3 layers of shrink wrap.

- **An alternative to shrink-wrapping is to use secondary outer packaging as this will provide added protection.** The outer packaging will need to be fastened by either gluing or stapling the base of the package to the pallet to make it secure. The boxes should then be evenly distributed inside the outer packaging making sure the contents are tightly packed to avoid movement. The top of the packaging should be levelled and then the lid secured.

Labelling of shipment



- Make sure the routing labels are placed on the side of the pallet load and clearly visible to enable the barcode to be scanned.
- Use orientation labels to help us with the identification of the type of shipment and required handling practices such as 'This Way Up'; 'Fragile; Handle with Care'

Dangerous Goods Shipments via FedEx Express

Dangerous goods must be tendered to FedEx Express according to both current International Air Transport Association (IATA) regulations for air transport and the FedEx Express Terms and Conditions.

If you have other questions, call your local customer service team or go to [fedex.com](https://www.fedex.com).

Surcharges

Please note that shipments which are not fully incased in an outside shipping container, corrugated fiberboard (cardboard) box, or other suitable packaging as determined by FedEx, an additional handling surcharge may apply.

This document only provides a general overview of some surcharges that you may incur in relation to your shipment. Please visit [fedex.com](https://www.fedex.com) or contact your local FedEx customer service for details of applicable surcharges that may apply to your shipment.

Bubble Wrap is a registered trademark of Sealed Air Corporation.

NOTICE: These General Packaging Guidelines are provided to FedEx customers to help reduce loss or damage due to improper packaging. This document is not intended to be a comprehensive guide for packaging shipments that FedEx will accept for transit. We make no warranties, expressed or implied, regarding this information. Proper packaging is the sole responsibility of the shipper. For more information and additional guidelines, go to the packaging tips page on [fedex.com](https://www.fedex.com), or contact your local customer service team. Refer to the current FedEx Standard Conditions of Carriage for terms, conditions, and limitations applicable to your express shipments.

© 2023 FedEx. All rights reserved.



Packaging Perishable Shipments

To help prevent spoilage and maintain product integrity, follow these instructions for shipping your perishable items via FedEx Express® services. Not all commodities are accepted by local markets. Please contact your local customer service team for shipment acceptance.

Contents

Preparing Perishable Items for Shipment	13
How to Keep Products Refrigerated During Transit	14
How to Keep Products Frozen During Transit	15
Shipping Seafood With Wet Ice	17
How to Protect Products From Freezing	17
Sealing and Labeling Instructions	18
The FedEx Express Transportation Environment	18
FedEx Package Testing and Design Services	18



Preparing Perishable Items for Shipment

Perishable products may be subjected to harsh environmental conditions, such as excessive temperature or humidity, on the way to their destination. We do not provide temperature-controlled shipping services for express shipments. However, with careful packaging, you can protect your products by providing appropriate temperature protection or stability.

During shipping, insulation and refrigerants are key to preserving products like seafood, plants, meat, and fruits as well as dairy, medical, and chemical products. With the proper combination of insulation and refrigerants, you can maintain products within specific temperature ranges. You can keep products frozen, or prevent products from freezing. You can prevent melting and thawing in hot weather and minimize the effects of short-term temperature variations. We'll show you how.

Insulation

We recommend insulation to reduce the transfer of heat through packaging container walls. The most common insulation materials are expanded polystyrene (EPS) foam, rigid polyurethane foam, and reflective materials (radiant barrier films).

Refrigerants

We recommend refrigerants such as gel coolants and dry ice* to keep perishable products cold or frozen. However, do not use dry ice as a refrigerant for live seafood such as lobsters; use gel coolants instead. Wet ice has many disadvantages, including weight and special water-resistant packaging requirements, but it may be used if approved in advance by FedEx. Please call your local customer service team for details.

General Guidelines for Packaging Perishables

- Package shipments to withstand handling in different orientations.
- Use a refrigerant that will keep products within the required temperature range. Use gel coolants for refrigerating products between 0 C (32 F) and 16 C (60 F). Use dry ice* for frozen items.

* Dry ice (carbon dioxide solid, UN 1845) is considered a dangerous good/hazardous material for air transport and requires special handling. See the "[Dry Ice Shipping Regulations](#)" section for details.

- Use insulated foam containers with a minimum of 4-cm- (1-1/2"-) thick walls.
- Bag perishable products that can melt or thaw, or shipments that contain liquid, using minimum 2-mil watertight plastic bags.
- Place foam containers inside sturdy outer containers.
- Include the address and 24-hour phone number of both the shipper and the recipient on each shipping label.

Express Service Recommendations

- The maximum acceptable gross weight per package for most FedEx Express overnight services is 68 kg (150 lbs.), including packaging and refrigerant.
- We recommend that you package perishables for a minimum transit time of 30 hours.
- Avoid shipment of perishable items on days that will require transit on a weekend or over a holiday period.

How to Keep Products Refrigerated During Transit

Gel coolants are preferable to wet ice.

- Freeze the coolants according to the manufacturer's guidelines.
- Precool the insulated container, if possible.
- If your shipment contains liquid or perishable products that could contain liquids, double-bag the products using minimum 2-mil watertight plastic bags and line the inside of the foam container with a minimum 2-mil plastic liner and absorbent material.
- Arrange products inside the insulated container, allowing space for coolants.
- Place a sufficient number of coolants on top of and around the product.
- Fill all void space with dunnage such as loosefill peanuts to prevent product movement.
- Close the liner bag securely.
- Place the insulated container inside a corrugated outer box.
- Close and securely seal the corrugated box with pressure-sensitive plastic tape. Apply the tape over all box flaps and seams.

Packaging Perishable Shipments With Gel Coolants

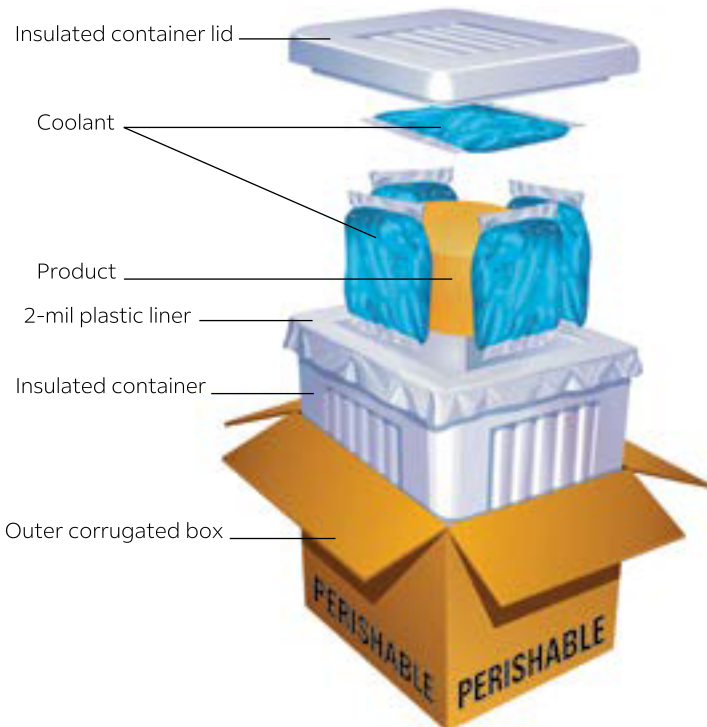

Bag Closure Instructions



Twist end of bag tightly. Fold over. Wrap rubber band securely around fold-over to ensure closure.

Packaging Seafood Shipments With Gel Coolants

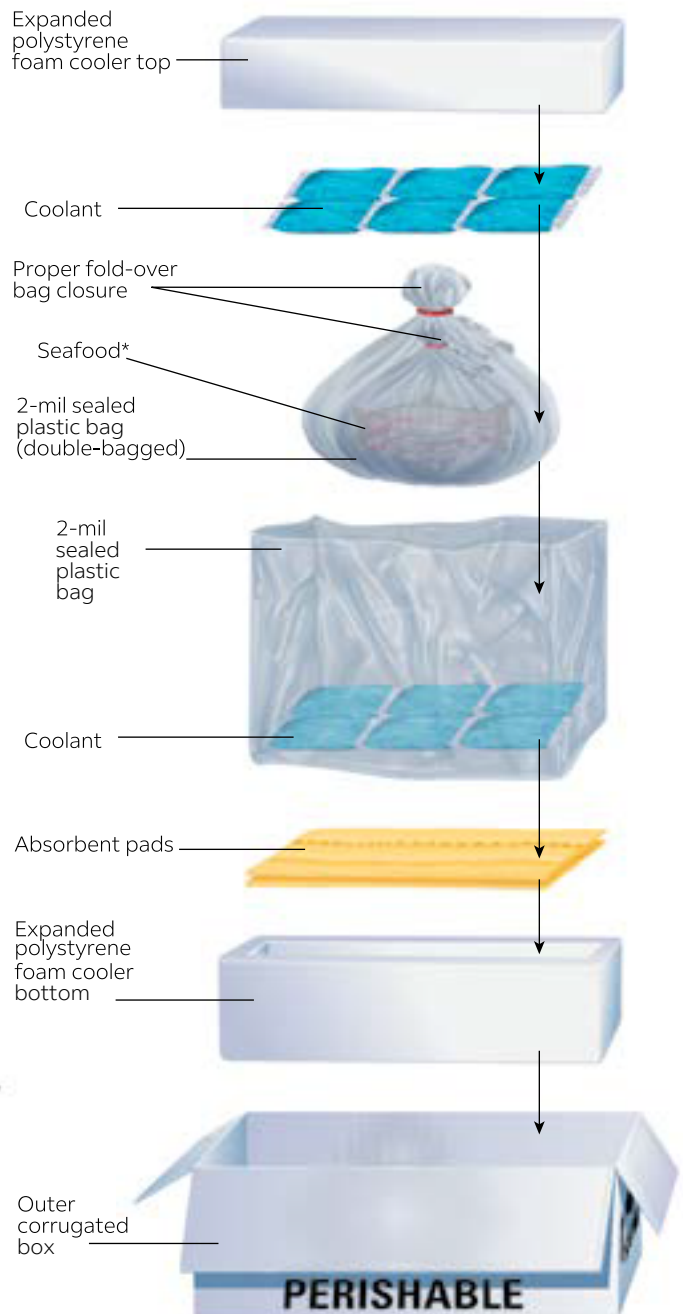

* When shipping live edible seafood (lobsters, oysters, crabs), use gel coolants and follow the same packaging steps except do not seal the bags.

How to Keep Products Frozen During Transit

- Freeze products before packaging.
- Precool the insulated container, if possible.
- If the shipment contains liquid or perishable products that can melt or thaw, bag the products or line the insulated container using a minimum 2-mil watertight plastic bag.
- When arranging products inside the insulated container, allow enough space for dry ice.
- Place a sufficient amount of dry ice in the insulated container on top of and around the products.
- Fill void spaces with dunnage material such as loosefill peanuts.
- Close the liner bag (if used) but do not completely seal it, as the carbon dioxide gas created by the dry ice must be allowed to vent.
- Place the lid on the insulated container.
- Place the insulated container inside an outer corrugated box.
- Close and securely tape the box with pressure-sensitive plastic tape. Apply tape to all flaps and seams.
- Complete the required paperwork, dangerous goods labeling, and markings.

Dry Ice Shipping Regulations

Dry ice (or carbon dioxide solid, UN 1845) is considered a dangerous good/hazardous material for air transport and requires special handling. Shippers are also required to have function-specific dangerous goods training as outlined in 49 Code of Federal Regulations (49CFR) 172.700.

When dry ice changes to carbon dioxide gas in enclosed spaces like aircraft cargo holds, it displaces oxygen. The design and construction of packaging used for dry ice shipments must prevent the buildup of pressure that could cause rupturing. Dry ice must never be placed in an airtight container.

When shipping with dry ice, you must provide correct identification, classification, markings, and labeling on your outer carton to comply with current requirements in the International Air Transport Association (IATA) dangerous goods regulations.

The following permanent markings are required on the outer packaging of all IATA dry ice shipments:

- “Dry Ice” or “Carbon Dioxide Solid.”
- “UN 1845.”
- Net weight of dry ice in kilograms.
- Name and address of the shipper.
- Name and address of the recipient.

FedEx Dry Ice Label

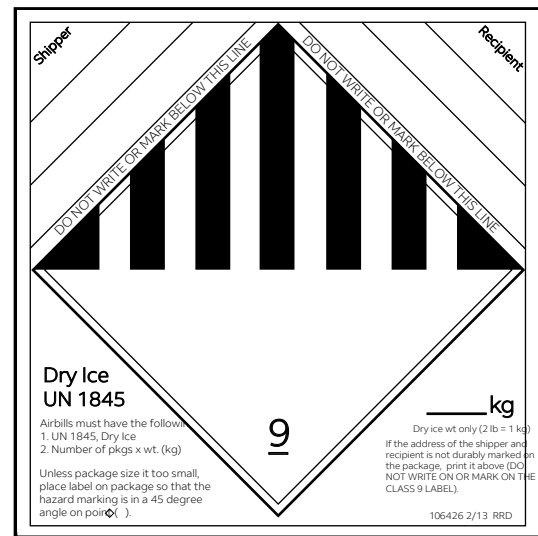

An IATA Class 9 Miscellaneous label must appear on all dry ice shipments. FedEx Express offers a dry ice label that, when correctly completed, satisfies the IATA marking and labeling requirements, available free of charge at [fedex.com](https://www.fedex.com) or by calling your local customer service team.

Whether you use online shipment processing at **fedex.com** or a FedEx airbill, select “Dry Ice” on your documentation and complete the dry ice information. In addition, mark “Yes, Shipper’s Declaration not required” in the Special Handling section on the airbill.

If you have questions or need more information about dry ice shipments, call your local customer service team.

Additional Requirements for Shipping Frozen Seafood

- Double-bag seafood in minimum 2-mil plastic bags, with each bag individually sealed using the fold-over method.
- Place adequate absorbent material such as pads, cellulose wadding, or paper towels in the bottom of the foam container to absorb any liquids.

Packaging Perishable Shipments With Dry Ice

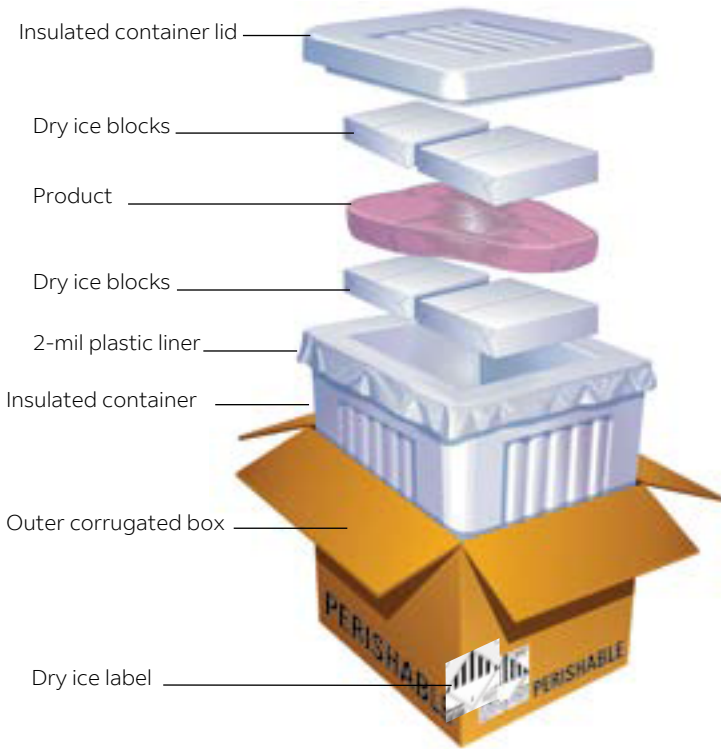

Packaging Frozen Seafood Shipments With Dry Ice

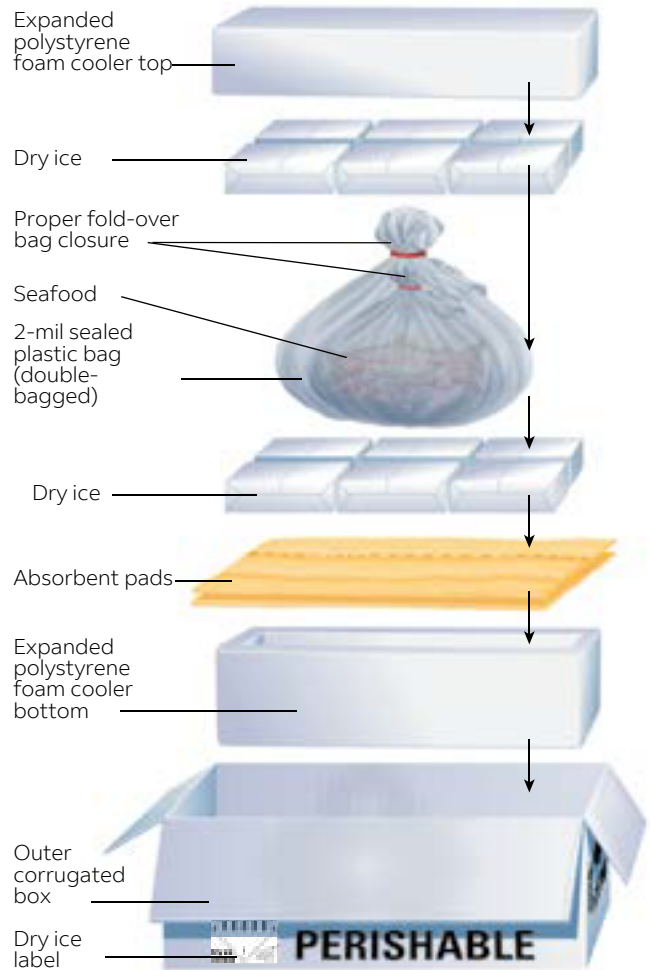

Shipping Seafood With Wet Ice

FedEx does not recommend the use of wet ice (frozen water) as a refrigerant. If you believe wet ice is necessary, you must prepare it to prevent the leakage of any liquid, regardless of orientation.

- Double-bag seafood in minimum 2-mil plastic bags, with each bag individually sealed using the fold-over method.
- Double-bag the ice in minimum 2-mil plastic bags, with each bag individually sealed using the fold-over method.
- Line the insulated container using a minimum 2-mil watertight plastic bag.
- Place adequate absorbent material such as pads, cellulose wadding, or paper towels in the bottom of the foam container to absorb any liquids.
- Follow all other packaging requirements for seafood shipments.

Packaging Seafood Shipments With Wet Ice



How to Protect Products From Freezing

You can help protect your products from low temperatures or freezing by using "heat sinks," which help maintain desired temperatures. Gel coolants make good heat sinks.

- Place your products inside an insulated container and surround them with room-temperature (about 22 C or 72 F) gel coolants to reduce the risk of freezing.
- Fill all void space with dunnage such as loosefill peanuts to prevent product movement.
- Ship the insulated container inside a corrugated box.

Packaging Perishables to Prevent Freezing

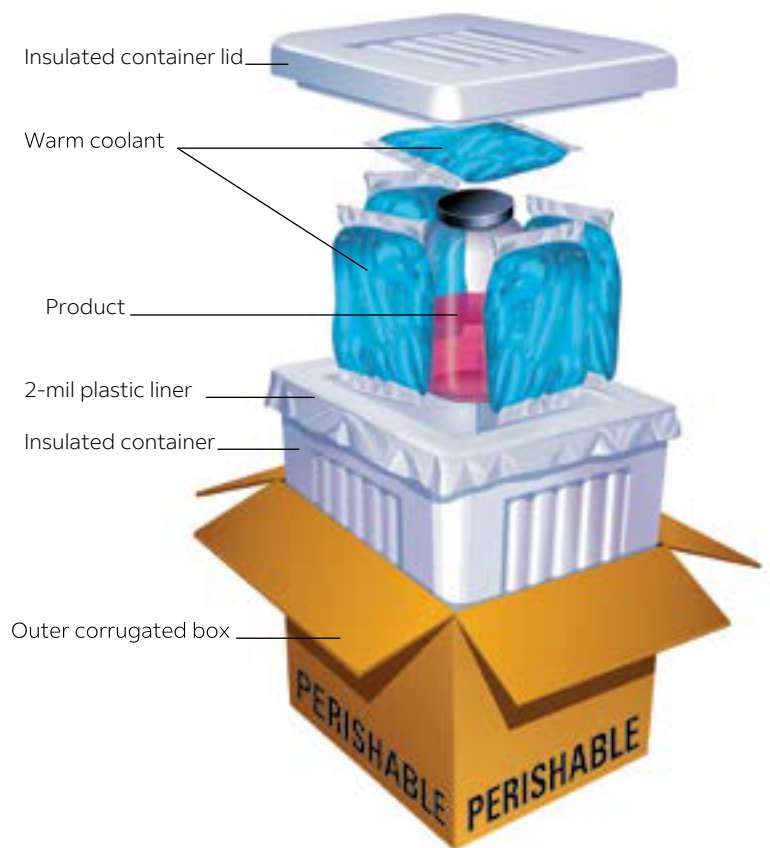

Sealing and Labeling Instructions

- Apply at least three strips of pressure-sensitive adhesive plastic tape that is at least 5 cm (2") wide to both the top and bottom of the carton.
- Tape all seams or flaps using the H taping method.
- Place the shipping label on the top of the largest surface.
- Mark your outer container "Perishable."

While we cannot ensure compliance with markings such as up arrows or "This End Up," properly placing the shipping label increases your chance for the preferred orientation.

Dry ice label (when required). Dry ice (carbon dioxide solid, UN 1845) is considered a dangerous good/hazardous material for air transport and requires special handling. See the "Dry Ice Shipping Regulations" section for details.

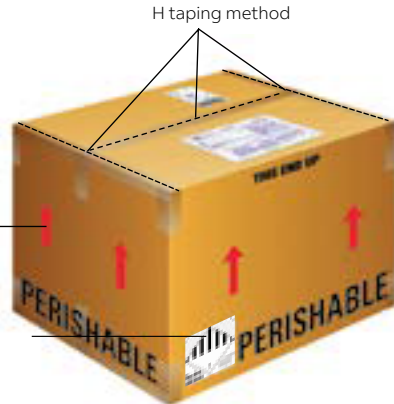

The FedEx Express Transportation Environment

Perishable products must withstand various temperature conditions in the FedEx Express shipping environment.

The cargo areas of our vans and trucks are not temperature-controlled, and temperature will vary depending on time of year, location, exposure to sunlight, and other variables. In summer months the temperature in the cargo area of ground vehicles can be as much as -1 C (30 F) higher than the ambient temperature outside the vehicle. On board FedEx Express aircraft, temperatures vary depending on the type of aircraft, the location of each cargo compartment and the package location within each compartment, the length of flight, and the cruising altitude. For general reference, temperatures aboard most wide-body aircraft main cargo compartments vary between 18 C (65 F) and 32 C (90 F). Packages positioned in the bulk department, next to the aircraft's outer structure, might be exposed to temperatures as low as -18 C (0 F) during flight.

Air pressures on FedEx Express aircraft vary from as low as 8.3 psi at cruise altitude to as much as 14.7 psi on the ground.

FedEx Package Testing and Design Services

We offer package testing, evaluation, and design services that can help you predict packaging performance and avoid product spoilage. We encourage you to submit a sample of your perishables packaging for testing and evaluation. For details or to request your package testing or evaluation, please contact your FedEx account executive.

NOTICE: This packaging brochure is provided to FedEx customers to help reduce loss or damage due to improper packaging. It is NOT intended to be a comprehensive guide for packaging items we accept for transit. We make no warranties, expressed or implied, regarding this information. Proper packaging is the sole responsibility of the shipper. For more information and additional guidelines, go to the packaging tips page on [fedex.com](https://www.fedex.com) or contact your local customer service team. Refer to the current FedEx Standard Conditions of Carriage for terms, conditions, and limitations applicable to your express shipments.

© 2017 FedEx. All rights reserved.



Packaging Flowers and Plants

To help ensure that your fresh flowers and live plants arrive in top condition, follow these instructions for packaging and shipping via FedEx Express® services. Not all commodities are accepted by local markets. Please contact your local customer service team for shipment acceptance.

Contents

Packaging Requirements	20
Preparing Flowers and Plants for Shipment	20
Express Service Recommendations	21
Sealing and Labeling Instructions	22
FedEx Package Testing and Design Services	22



Packaging Requirements

Observe the following general requirements when packaging your shipments:

- Secure contents inside the shipping container, because directional arrows cannot always be honored, and plants and flowers may be shipped in different orientations.
- Protect flowers and plants from temperature extremes that may occur during shipment or after delivery at the recipient's location; for climate protection, see the perishables section of the How to Pack guidelines at [fedex.com](https://www.fedex.com).
- To prevent leaks and spills, ship vases or containers without water and cover soil in pots and plant containers.
- Place your shipping label on the top of the box to increase the chance of shipment in the preferred orientation.
- Make sure your shipments comply with any applicable local, state, and federal laws governing shipment of flowers and plants.

Preparing Flowers and Plants for Shipment

From floral arrangements to bulk flowers, seedlings to mature plants, packaging requirements vary based on the contents of your shipment. The instructions and illustrations are provided here to help you develop effective packaging for your shipments.

Floral Arrangements

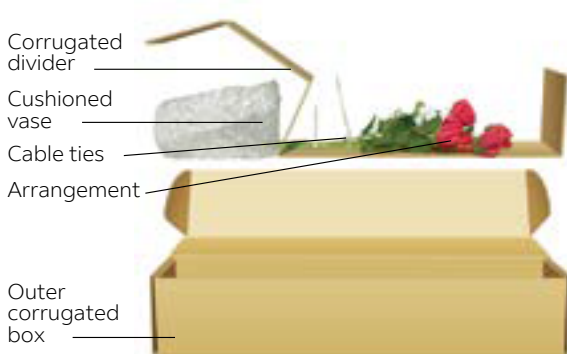

Secure floral arrangements inside a box using cable ties or bands secured to the box or to an inside insert to prevent shifting of the arrangement during shipment. If you are shipping a vase with the arrangement, also secure the vase inside the box. We recommend a corrugated divider

to separate the vase from the flowers. If the vase is fragile, use additional packaging materials to cushion the vase and protect it from damage during shipment. Ship vases or containers without water; shipping with water is prohibited because it may leak during shipment and cause product damage or safety issues.

Plant Seedlings and Plugs

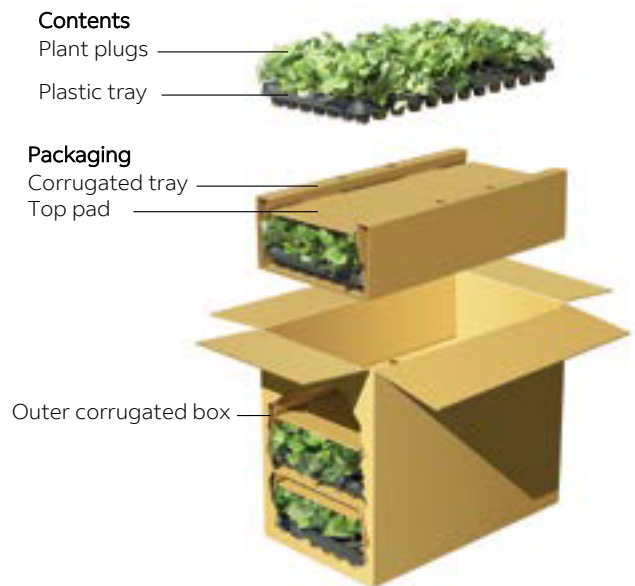

Plant seedlings and plugs are fragile and difficult to secure in the shipping carton, so they require special attention. We recommend a corrugated tray with a top pad designed to push lightly against seedlings or plugs to secure them in their plastic tray during shipment. This packaging method works best with leafy seedlings and plugs, not tall and spindly plant material. You can also use plastic mesh over the plant plugs to provide added security. The moisture content of the soil is also an important consideration during shipment. If the soil is too dry, plugs are more likely to spill out of the plastic tray. If the soil is too wet, the corrugated tray may weaken from the moisture. Since you cannot secure plant plugs individually inside the plastic tray, you can expect some plugs to be dislodged during transit and some soil to sift out of the plastic tray, so plan accordingly when preparing your shipment.

Plants

When shipping plants, secure them to prevent movement inside the shipping carton. If the plant shifts inside the carton, it can cause breakage of plant stems and leaves, so we recommend using a corrugated divider that locks the pot inside the box. The soil inside the box must also be contained. Place the pot in a plastic bag and secure the top opening of the bag around the stem of the plant. If the plant does not have a single main stem, you can place paper between the leaves and over the soil and secure it to the pot.



Orchids

Orchids require special packing because they are inherently fragile. When shipping multiple orchids, secure the pots in the shipping carton with enough space to keep plants separated during shipment. Contact between the plants' blooms and leaves can lead to damage. You can also wrap the blooms and leaves in paper to provide extra cushioning when shipping. Cold temperatures can be harmful to tropical flowers like orchids, so when shipping to cold climates make sure your packaging is designed to protect the flowers from temperature variations during shipment.

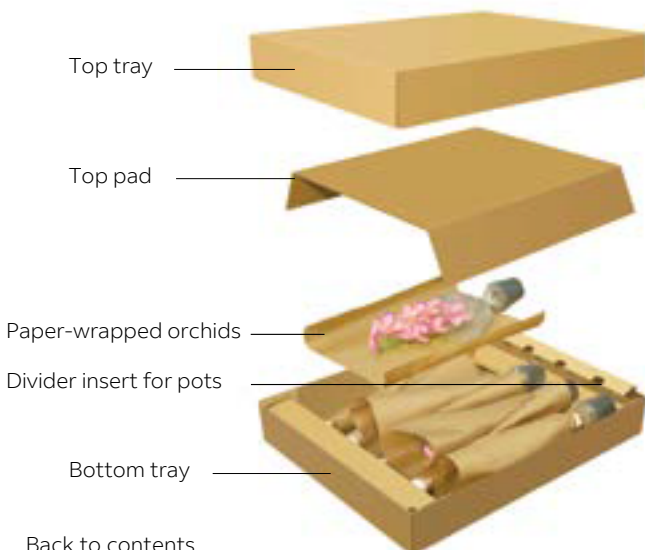

Bulk Flower Shipments

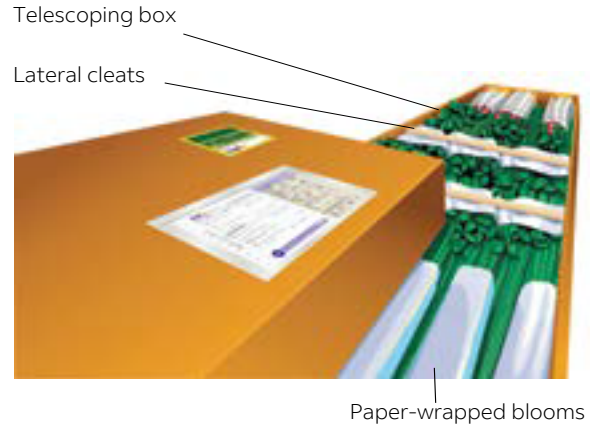

Place bulk flowers in telescoping boxes that accommodate the size of your plant material. Ideally, the boxes should measure less than 97 cm (38") in length, 61 cm (24") in height and 66 cm (26") in width. Use lateral cleats or bands to prevent shifting of the flowers inside the box. Choose corrugated shipping cartons constructed with moisture-resistant adhesive, because when the box is precooled, temperature and humidity can weaken it. We recommend that you use tape to secure the box. Straps can be used, but they tend to loosen during shipment and may compromise the closure of the box. Do not use string or twine to secure the box.

Express Service Recommendations

- The maximum acceptable gross weight per package for most FedEx Express overnight services is 68 kg (150 lbs.), including packaging and refrigerant.
- We recommend that you package flowers and plants for a minimum transit time of 30 hours.
- Avoid shipment of perishable items on days that will require transit on a weekend or over a holiday period.

Sealing and Labeling Instructions

- Apply at least three strips of pressure-sensitive adhesive plastic tape that is at least 5 cm (2") wide to both the top and bottom of the carton.
- Tape all seams or flaps using the H taping method.
- Place the shipping label on the top of the largest surface.

While we cannot ensure compliance with markings such as up arrows or "This End Up," properly placing the shipping label increases your chance for the preferred orientation.

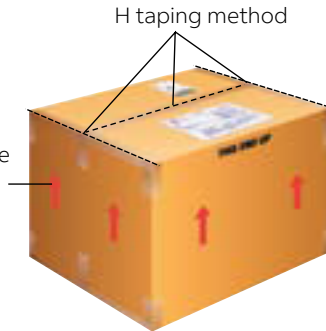

FedEx Package Testing and Design Services

We offer package testing, evaluation, and design services that can help you predict packaging performance and avoid product spoilage. We encourage you to submit a sample of your perishables packaging for testing and evaluation. For details or to request your package testing or evaluation, please contact your FedEx account executive.

NOTICE: This packaging brochure is provided to FedEx customers to help reduce loss or damage due to improper packaging. It is NOT intended to be a comprehensive guide for packaging items we accept for transit. We make no warranties, expressed or implied, regarding this information. Proper packaging is the sole responsibility of the shipper. For more information and additional guidelines, go to the packaging tips page on [fedex.com](https://www.fedex.com) or contact your local customer service team. Refer to the current FedEx Standard Conditions of Carriage for terms, conditions, and limitations applicable to your express shipments.
© 2017 FedEx. All rights reserved.



Packaging Computer Shipments

To help protect your computers and peripherals from shock and vibration during transit, follow these instructions for shipping via FedEx® services.

Contents

Recommended Packaging Options	24
Shipping With Original Manufacturer's Packaging	24
Shipping Without Original Manufacturer's Packaging	24
Sealing and Labeling Instructions	26
Shipping in a FedEx Laptop Box	26
Shipping in a Transit Case	27
Packaging Freight Shipments	27
General Guidelines for Shipping Computer Parts and Peripherals	28
FedEx Package Testing and Design Services	28



Recommended Packaging Options

This brochure will help you pack and prepare your computer and peripheral shipments. Follow the instructions for the packaging method of your choice.

- Shipping with original manufacturer's packaging.
- Shipping without original manufacturer's packaging.
- Shipping in a transit case.
- Packaging freight shipments.

Shipping With Original Manufacturer's Packaging

Original packaging is usually designed to ship the product once, not multiple times. Reuse can weaken the packaging and place the inside product at risk. Overboxing provides extra integrity for the weakened original manufacturer's packaging.

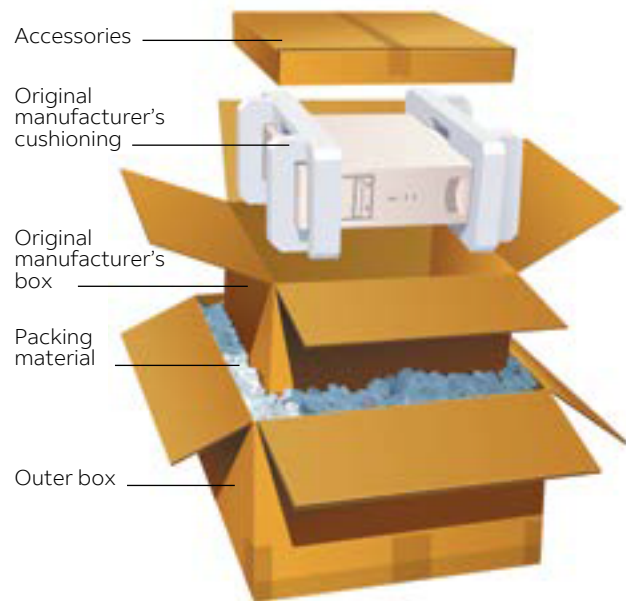

Using Original Packaging and an Outer Box

Inspect the original packaging to ensure that the cushioning material and box are intact and unbroken. Make any repairs with pressure-sensitive adhesive plastic tape that is at least 5 cm (2") wide. Pack the product using all the original packaging components.

Obtain a box that is at least 15 cm (6") larger in length, width, and height than the original manufacturer's packaging.

Fill the bottom of the box with 8 cm (3") of packing material (e.g., air-cellular cushioning such as Bubble Wrap® or loosefill peanuts). Do not use crushed paper. Center the original manufacturer's packaging inside the outer box and fill empty spaces on all sides and the top with packing material. The inner box should be surrounded with at least 8 cm (3") of packing material around all six sides of the inner box.

Apply at least three strips of pressure-sensitive adhesive plastic tape that is at least 5 cm (2") wide to both the top and bottom of the carton to protect the package and its contents. Tape all seams or flaps.

Shipping Without Original Manufacturer's Packaging

We recommend three methods for shipping your computers and peripherals if you don't have, or prefer not to use, the original manufacturer's packaging.

Using Air-Cellular Cushioning Material

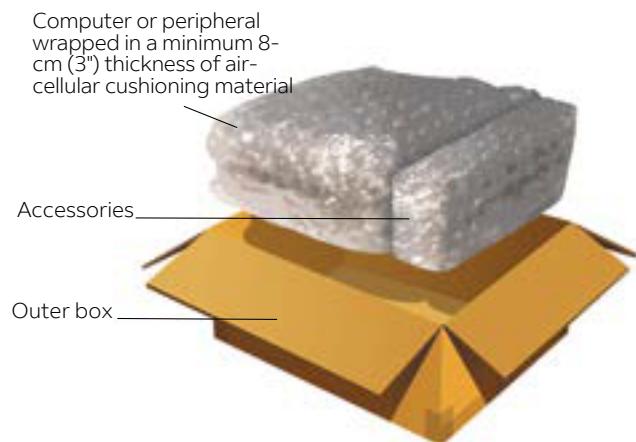

Wrap the computer or peripheral on all sides with at least 8 cm (3") to 10 cm (4") of air-cellular cushioning material. Place the wrapped item inside a sturdy outer box. Accessories that are wrapped in appropriate amounts of cushioning can also be placed in any open spaces of the box. Fill all spaces with additional cushioning so that the wrapped item fits tightly inside the box. If no open spaces exist, pack accessories in an additional box.

Close and seal both the top and bottom of the box with three strips of pressure-sensitive plastic tape that is at least 5 cm (2") wide. Tape all seams or flaps.

Using Loosefill Peanuts

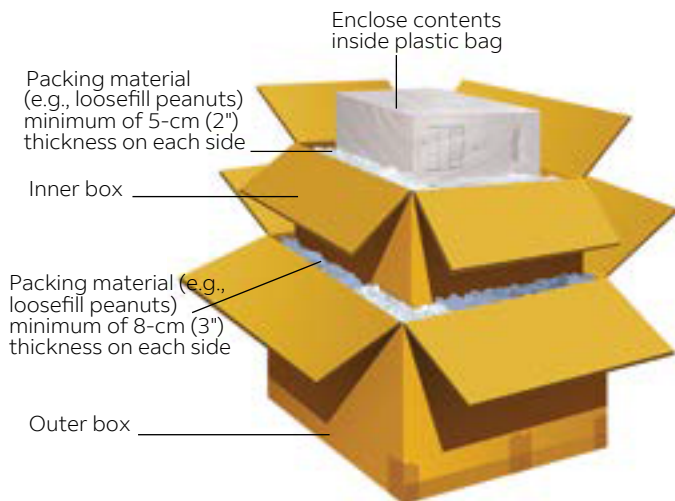

Since this type of packing material allows the packaged item to settle to the bottom of the box, it is important to use the overbox method of packaging. The inner box should be at least 10 cm (4") greater in length, width, and height than the item you are shipping. This will allow for 5 cm (2") of space for all six sides. The outer box should be at least 15 cm (6") greater in length, width, and height than the inner box. This will allow 8 cm (3") of space between the inner box and the outer box.

Wrap the computer or peripheral in a plastic bag to prevent the loosefill peanuts from getting inside the unit. Fill the bottom of the inner box with at least 5 cm (2") of loosefill peanuts and center the wrapped item inside the box. Fill empty spaces on all sides and top with loosefill peanuts, ensuring that there is at least 5 cm (2") of loosefill peanuts on all six sides of the item. Pack accessories such as power cords, keyboards, and external drives separately, away from the computer or peripheral.

Close and seal both the top and bottom of the box with three strips of pressure-sensitive plastic tape that is at least 5 cm (2") wide.

Fill the bottom of the outer box with at least 8 cm (3") of loosefill peanuts and center the inner box inside the outer box. Fill empty spaces on all sides and top of the inner box with loosefill peanuts, ensuring that there is at least 8 cm (3") of loosefill peanuts on all six sides.

Close and seal both the top and bottom of the box with three strips of pressure-sensitive plastic tape that is at least 5 cm (2") wide. Tape all seams or flaps.

Using Foam Corner Cushioning

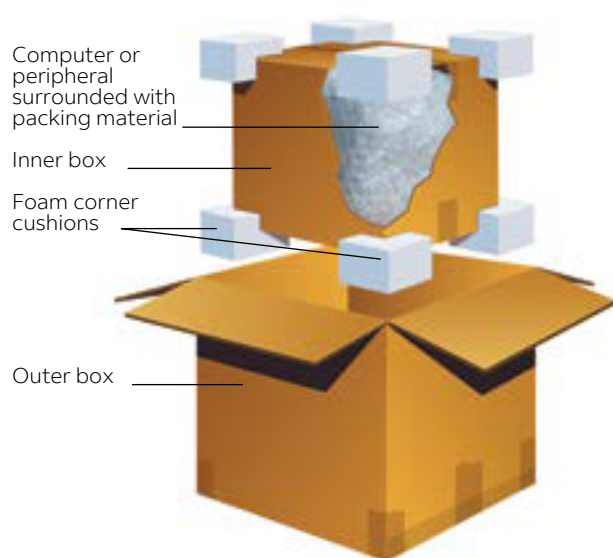

You may choose to use foam corner cushioning specifically designed to properly cushion your product during shipping. This packing method allows you to use one size of inner box, one size of outer box and one type of foam corner cushioning to ship items of various sizes and weights.

Place the computer or peripheral inside the box and surround the item with at least 4 cm (1-1/2") of packing material (e.g., loosefill peanuts, air-cellular cushioning, foam-in-place) on all sides so that the item does not move inside the box.

Close and seal the top and bottom of the inner box with three strips of pressure-sensitive plastic tape that is at least 5 cm (2") wide.

Place the box containing the item inside a larger (outer) box fitted with the foam corner cushions. The outer box must fit tightly around the foam corner cushions.

Close and seal the top and bottom of the outer box with three strips of pressure-sensitive plastic tape that is at least 5 cm (2") wide. Tape all seams or flaps.

Sealing and Labeling Instructions

- Using the H taping method, apply at least three strips of pressure-sensitive adhesive plastic tape that is at least 5 cm (2") wide to both the top and bottom of the carton.
- Tape all seams or flaps.
- Place the shipping label on the top of the largest side.

While we cannot ensure compliance with markings such as arrows or "This End Up," properly placing the shipping label increases your chance for the preferred orientation.

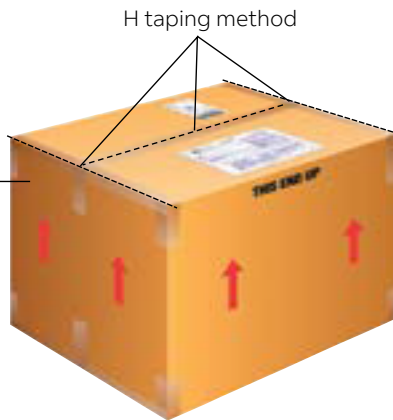

Place the laptop in the plastic bag, then place one foam pad above and one foam pad below the wrapped laptop. Adjust the slotted foam liner by tearing off just enough material to ensure a snug fit around the laptop. Close the box by inserting the flaps into the side walls. Seal the bottom edge of the laptop box with a strip of pressure-sensitive plastic tape that is at least 5 cm (2") wide.

Laptops have a rechargeable lithium ion battery inside them. Lithium ion batteries are a regulated dangerous goods under the International Air Transport Association (IATA)/International Civil Aviation Organization (ICAO) regulations. Obtain the Safety Data Sheet (SDS) from the battery manufacturer. If the battery is 100 Watts or less it may fall under a Section II lithium battery. Up to 2 may be shipped contained in the equipment (laptop) without any additional labeling or documentation. If more than 2 batteries are shipped in laptops per package, or if spare batteries are shipped in the same package but separate from the laptop itself, then a completed IATA Lithium Battery handling label is required on each package. In addition, alternate documentation such as a packing slip is required with 4 required bullets of information. These include:

Shipping in a FedEx Laptop Box

The FedEx Laptop Box may not be available in your market; please contact your local customer service team for FedEx supplies.

Laptop in plastic bag

One foam pad above and one foam pad below

Slotted foam liner, adjusted for a snug fit around laptop

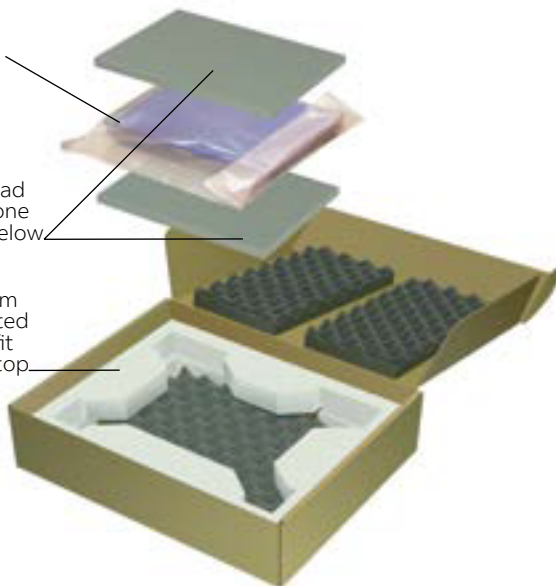

- The package contains Lithium Ion Batteries
- The package must be handled with care and that a flammability hazard exists if the package is damaged
- Special procedures must be followed in the event the package is damaged, to include inspection and repack-ing if necessary
- A telephone number for additional information

For additional questions, please refer to the current IATA/ICAO regulations.

When shipping a laptop computer, we recommend that you use our specially designed FedEx Laptop Box whenever possible. The box includes cushioning material and is available for purchase at FedEx World Service Center[®] locations.

Shipping in a Transit Case

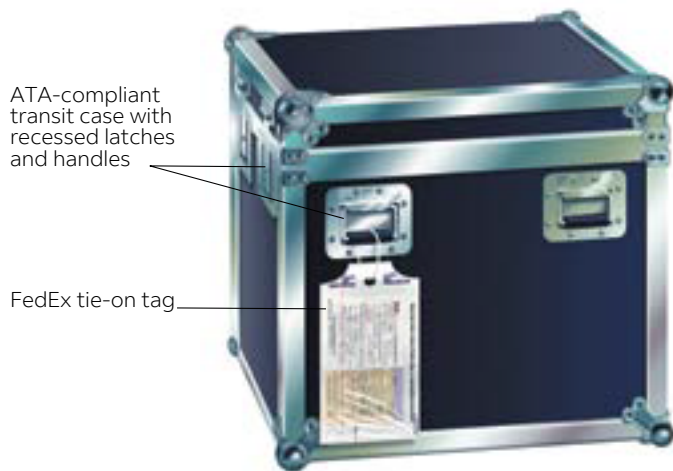

While transit cases can effectively protect computers and peripherals that will be shipped multiple times, care must be taken in the design of both the outer case and the inner cushioning.

When selecting a transit case, make sure the inner foam cushioning is designed to the proper fragility level to protect the computer or peripheral during shipping. Also make sure the outer case is manufactured in compliance with Airline Transport Association (ATA) standards. Handles, latches, wheels, and locks should be recessed into the case. Replace the foam cushioning inside the case periodically, because with use, the cushioning will break down and no longer provide proper protection for the product.

Attach the shipping label using a FedEx tie-on tag. (The FedEx tie-on tag may not be available in your market. Please contact your local customer service team for FedEx supplies.)

Packaging Freight Shipments

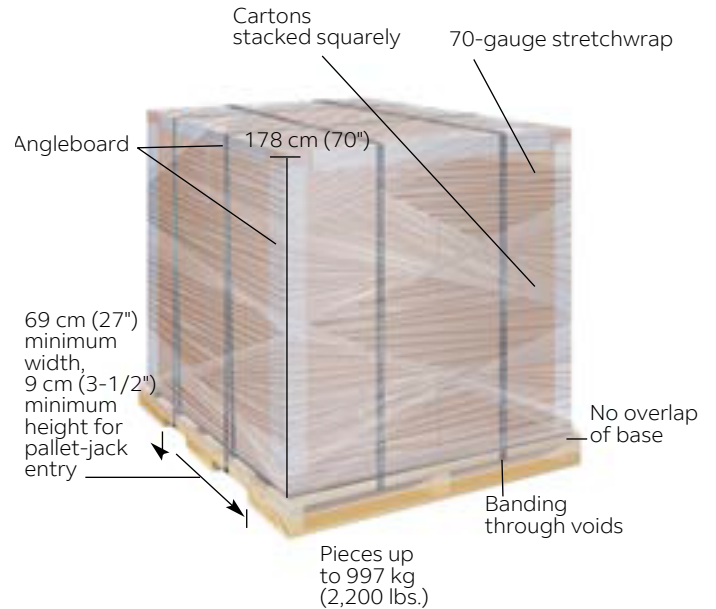

Shipments that qualify as freight must be packaged accordingly. See the current FedEx Service Guide to determine if your shipment qualifies as freight.

You must package your freight shipments to allow for stacking of other packages on top of your shipment. Make sure your freight shipments are banded and stretchwrapped to the pallet, with the bands running in both directions. (Pallet loads secured with only stretch-wrap are not acceptable.)

Avoid corrugated or fiberboard pallets. You must secure all freight shipments weighing 68 kg (151 lbs.) or more on a forkliftable base, compatible with pallet-jack usage. The minimum specifications for a typical base for forklift or pallet-jack configuration are illustrated above.

Express Freight Shipments

To lessen the possibility of damage or delay to your cargo, make sure that all single-piece cargo greater than 68 kg (150 lbs.) is banded on all sides with heavy-duty metal or break-resistant plastic banding.

If your cargo is a single piece contained within a hardened container (plywood, metal) and is greater than 68 kg (150 lbs.), it does not require banding if exterior locks or clamps are used. (Glue, nails, or screws are not sufficient.)

General Guidelines for Shipping Computer Parts and Peripherals

Whichever packaging method you use, you'll find the following tips helpful when packing specific items.

Monitors

Remove the base and any attachments from the monitor when possible. Ship the monitor face-down.

Printers

Remove printing cartridges before shipping, and place cartridges inside a sealed plastic bag to prevent ink or powder from leaking into the box. Tape moving parts such as doors and print heads to secure them during transit. Remove any paper trays and pack them separately.

Scanners

Most manufacturers recommend that you secure the scanner carriage to prevent movement when shipping. Refer to your owner's manual for more information.

Computer Housings With or Without Internal Components

Packaging designed for computer housings without internal components is usually designed for the weight of the empty housing. If you assemble and install inner components (such as circuit boards and disk drives), make sure your packaging can accommodate the increased weight. For security reasons, you may want to encrypt or remove any confidential data stored on the computer before shipping. Overbox shipments of assembled units in original packaging.

Data Storage Devices

Before shipping CDs, memory sticks, magnetic tapes, or other data storage media, you should back up any data stored on the devices. For security reasons, you may also want to remove or encrypt any sensitive personal, confidential, or financial information. FedEx liability for loss of any electronic data is limited only to the cost of the medium on which the data is stored. See Liabilities Not Assumed in the current FedEx Standard Conditions of Carriage.

Servers, Routers, Large Laser Printers

Due to the high value and variable weights and sizes of these units, we recommend that customers contact FedEx Packaging Services for packaging recommendations.

FedEx Package Testing and Design Services

We offer free package testing, evaluation, and design services that can help you predict packaging performance and avoid product damage. We encourage you to submit a sample of your packaging for testing and evaluation. For details or to request your package testing or evaluation, please contact your FedEx account executive.

Bubble Wrap is a registered trademark of Sealed Air Corporation.

NOTICE: This packaging brochure is provided to FedEx customers to help reduce loss or damage due to improper packaging. It is NOT intended to be a comprehensive guide for packaging items we accept for transit. We make no warranties, expressed or implied, regarding this information. Proper packaging is the sole responsibility of the shipper. For more information and additional guidelines, go to the packaging tips page on [fedex.com](https://www.fedex.com) or contact your local customer service team. Refer to the current FedEx Standard Conditions of Carriage for terms, conditions, and limitations applicable to your express shipments.

© 2017 FedEx. All rights reserved.



Packaging Clinical Samples

Follow these instructions for packaging, marking, and labeling clinical samples for shipment via FedEx Express® services. Not all commodities are accepted by local markets. Please contact your local customer service team for shipment acceptance.

Contents

Guidelines for Clinical Samples	30
General Packaging Guidelines	30
Packaging Examples	30
Marking and labeling	31
FedEx Clinical Packaging Options	31



Guidelines for Clinical Samples

This brochure outlines the requirements for shipping with FedEx Express. In addition, all shipments must comply with all applicable local, state, and federal laws governing packing, marking, and labeling. Blood, urine, fluids, and other specimens containing or suspected of containing infectious substances must be shipped according to applicable government, International Air Transport Association (IATA), and International Civil Aviation Organization (ICAO) regulations.

For the purposes of this guide, clinical samples are generally defined as non-infectious human or animal materials including, but not limited to, excreta, secreta, tissue and tissue fluids, blood, and FDA-approved pharmaceuticals that are blood products.

General Packaging Guidelines

Liquid Samples

- 1. Primary watertight inner receptacle.** Use watertight containers for liquid specimens with a positive closure such as a screw-on, snap-on, or push-on lid, taped for an additional seal. If you place multiple fragile primary receptacles in a single secondary receptacle, they must be individually wrapped or separated to prevent contact between them.
- 2. Absorbent material.** Place absorbent material between the primary and secondary receptacles, using enough material to absorb the entire contents of all primary receptacles. Suggested absorbent materials include cellulose wadding, cotton balls, superabsorbent packets, and paper towels.
- 3. Secondary watertight inner receptacle.** Use a watertight sealed plastic bag, plastic canister, or screw-cap can.
- 4. Sturdy outer packaging.** Use rigid outer packaging constructed of corrugated fiberboard, wood, metal, plastic, or other equally strong material, including cylinders made of such materials and appropriately sized for the contents. Chipboard or paperboard boxes, paper envelopes, and plastic bags are unacceptable outer packaging. The completed packaging must be of good quality, strong enough to withstand the normal rigors of transportation without loss of contents as a result of vibration, changes in temperature, humidity, or pressure.

Packaging Examples

Primary Watertight Receptacles

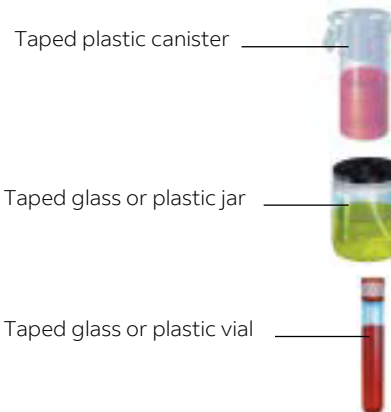

Absorbent Materials

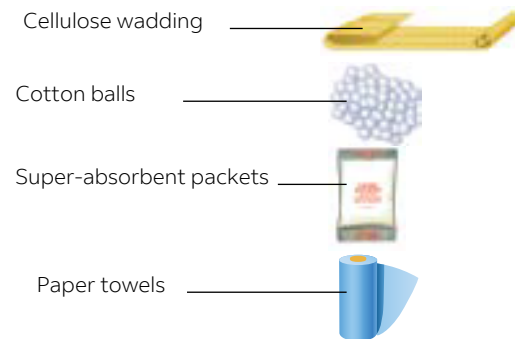

Secondary Watertight Receptacles



Marking and Labeling

Mark the package as “Exempt Human Specimen” or “Exempt Animal Specimen” as appropriate. If you prefer, package markings may be in the form of a label.

Dried Samples

Place dried samples, including but not limited to hair, swabs, or dried blood, into a sealed paper or plastic envelope and then into a 6" x 8" or larger mailing envelope. Cushion samples on glass or plastic slides and package in a sturdy outer container to prevent breakage and puncturing.

Note: If the dried sample is placed in a receptacle with a liquid preservative, then follow the packaging guidelines for liquids.

FedEx Clinical Packaging Options

The FedEx[®] Clinical Pak, FedEx[®] Medium Clinical Box, and FedEx[®] Large Clinical Box may not be available in your market. Please contact your local customer service team for FedEx supplies.

For your convenience, we offer the FedEx Clinical Pak, the FedEx Medium Clinical Box, and the FedEx Large Clinical Box as packaging options for exempt clinical sample shipments. We recommend the FedEx Clinical Pak for use when the sturdy outer packaging of your properly packaged shipment is smaller than 7" x 4" x 2" (minimum acceptable package size).

FedEx Clinical Pak



FedEx Large Clinical Box, FedEx Medium Clinical Box



To help ensure the timely delivery of your shipment and the safety of shipments exposed to yours, our clinical paks and boxes help your clinical shipments stand apart from other shipments.

Packaging Guidelines for FedEx Clinical Paks and Boxes

- The FedEx Clinical Pak is an overwrap primarily designed for easy identification and to handle smaller completed packages.
- The FedEx Clinical Pak can only be used to ship clinical samples. If you need an overpack for shipments containing Biological Substance, Category B (UN 3373) materials, use the FedEx UN 3373 Pak.
- Liquid blood and liquid blood products must always be placed in sturdy outer packaging before being placed in the FedEx Clinical Pak.
- The FedEx Clinical Pak can be used to ship dried samples when packaged according to the dried sample guidelines.
- The FedEx Medium Clinical Box and the FedEx Large Clinical Box can be used to ship clinical samples. Other FedEx packaging is not acceptable as outer containers for clinical samples.
- Shipments marked or labeled as hazard class 6.2 (infectious materials) and shipments containing dry ice cannot be shipped in FedEx packaging.

If you have questions about whether your shipments require a biohazard label, consult the Occupational Safety and Health Administration (OSHA) for the applicable regulations.

Note: Select FedEx World Service Center[®] locations accept non-infectious clinical shipments that are not classified as Biological Substance, Category B (UN 3373).

FedEx Package Evaluation Services

We offer package evaluation services that can help you predict packaging performance. We encourage you to submit a sample of your clinical sample packaging for evaluation. For details or to request your package evaluation, please contact your FedEx account executive.

NOTICE:

FedEx Express will refuse to accept packages that do not meet FedEx Express, government, or IATA and ICAO requirements. This brochure is in no way intended to replace requirements mandated by 49 Code of Federal Regulations (49CFR) and IATA. This is for informational purposes only.

Tyvek is a registered trademark of E.I. Du Pont De Nemours and Company.

NOTICE: This packaging brochure is provided to FedEx customers to help reduce loss or damage due to improper packaging. It is NOT intended to be a comprehensive guide for packaging items we accept for transit. We make no warranties, expressed or implied, regarding this information. Proper packaging is the sole responsibility of the shipper. For more information and comprehensive guidelines, contact your local customer service team. Refer to the current FedEx Standard Conditions of Carriage for terms, conditions, and limitations applicable to your express shipments.

© 2017 FedEx. All rights reserved.

Packaging UN 3373 Shipments

Follow these instructions for packaging, marking, and labeling Biological Substance, Category B (UN 3373) shipments for FedEx Express[®] services. Not all commodities are accepted by local markets. Please contact your local customer service team for shipment acceptance.

Contents

Requirements for Biological Substance, Category B (UN 3373) Shipments	34
General Packaging Requirements	34
Biological Substance, Category B (UN 3373) Marking Requirements	35
FedEx [®] UN 3373 Packaging Options	35
FedEx Packaging Services	36



Requirements for Biological Substance, Category B (UN 3373) Shipments

This guide outlines the requirements for shipping with FedEx Express. In addition, all shipments must comply with all applicable local, state, and federal laws governing packing, marking, and labeling. Blood, urine, fluids, and other specimens containing or suspected of containing infectious substances must be shipped according to applicable government, International Air Transport Association (IATA), and International Civil Aviation Organization (ICAO) regulations.

Customers who ship Biological Substance, Category B (UN 3373) shipments must comply with local, state, and federal laws governing identification, classification, packaging, and package markings (which may be in label form). FedEx Express strictly adheres to the IATA, ICAO, and local country or territories regulations for materials categorized as Biological Substance, Category B (UN 3373).

General Packaging Requirements

For Biological Substance, Category B (UN 3373) shipments, cushioning material is required for both liquid and dried specimens. You must include four layers of packaging:

- 1. Primary watertight inner receptacle.** Use primary receptacles made of glass, metal, or plastic with a positive means of ensuring a leakproof seal; skirted stopper or metal crimp seal must be provided; screw caps must be reinforced with adhesive tape. For liquid specimens, the primary receptacle must not contain more than 1 L. For dried specimens, the primary receptacle must not exceed the outer packaging weight limit.
- 2. Absorbent material.** Place absorbent material between the primary and secondary receptacles, using enough material to absorb the entire contents of all primary receptacles. Absorbent material is required for Biological Substance, Category B (UN 3373) shipments containing liquids. Acceptable absorbent materials include cellulose wadding, cotton balls, super-absorbent packets, and paper towels.
- 3. Secondary watertight inner receptacle.** Use a secondary container that is leakproof for liquid specimens or siftproof for dried specimens. Choose only secondary containers certified by the manufacturer for Biological Substance, Category B (UN 3373) prior to use. Either your primary or secondary receptacle must be able

to withstand, without leakage, an internal pressure differential of not less than 95 kPa in the range of -40 C to 55 C (-40 F to 130 F). To prevent contact between multiple fragile primary receptacles, individually wrap or separate them inside the secondary container.

4. Sturdy outer packaging. Use rigid outer packaging constructed of corrugated fiberboard, wood, metal, or plastic, or other equally strong material, including cylinders made of such materials and appropriately sized for the contents. Chipboard or paperboard boxes are unacceptable outer packaging. The completed packaging must be of good quality, strong enough to withstand the normal rigors of transportation without loss of contents as a result of vibration, changes in temperature, humidity, or pressure. Limit the total volume for liquid samples to 4 litres and the total weight of dried samples to 4 kg per outer container. At least one surface of the outer packaging must have a minimum dimension of 100 mm x 100 mm (4" x 4"). Completed packages must be able to withstand a 4' (1.2-m) impact test. Before sealing the outer packaging, you must make an itemized list of the contents of the package and enclose the list between the secondary packaging and outer packaging.

Acceptable Primary Receptacles

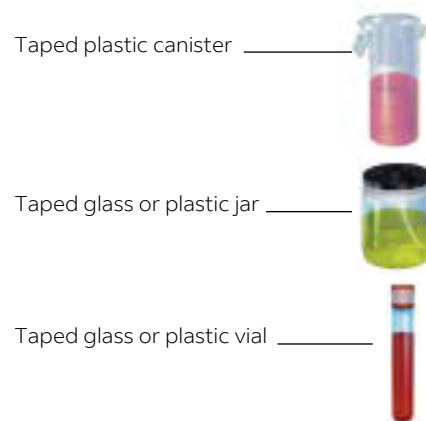

Acceptable Absorbent Materials

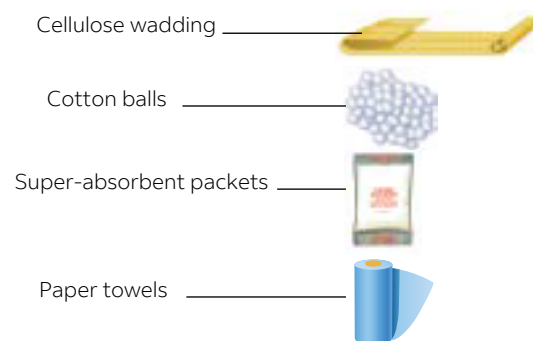

Acceptable Secondary Receptacles



Biological Substance, Category B (UN 3373) Marking Requirements

- Clearly mark “Biological Substance, Category B” in 6-mm-high text on the outer package adjacent to a properly sized UN 3373 diamond-shaped marking. If you prefer, package markings may be in the form of a label.
- If you use the FedEx® Medium Clinical Box or the FedEx® Large Clinical Box to ship samples classified as Biological Substance, Category B (UN 3373), you must add a properly sized UN 3373 diamond-shaped marking. If you prefer, package markings may be in the form of a label.
- If you use the FedEx® UN 3373 Pak, FedEx Medium Clinical Box, or FedEx Large Clinical Box, duplicate all required dangerous goods markings on each package inside the overpak or box. Do not place dry ice inside the pak.
- The name and telephone number of a person responsible must be marked on the package or provided on the airbill.
- The name and address of the shipper and recipient must be marked on the package. However, when the shipper or recipient is also the “person responsible,” the name and address need only be marked once in order to satisfy the name and address provisions.

Biological Substance, Category B (UN 3373) Marking Requirements

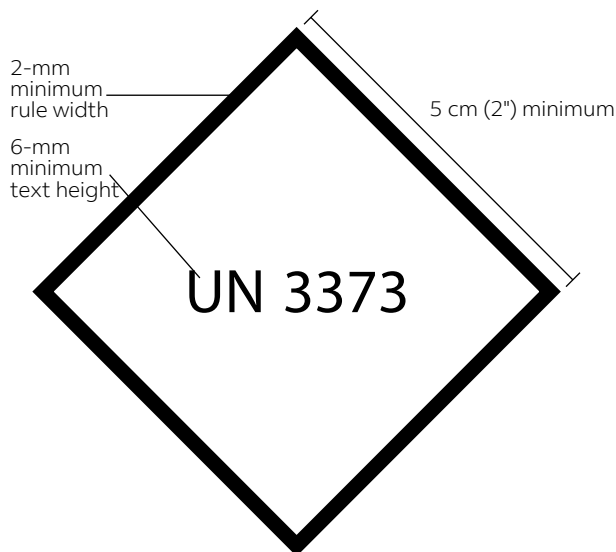

“Biological Substance, Category B” must appear in 6-mm-high text on the outer package adjacent to a diamond-shaped mark like the one shown here. The UN 3373 marking must be in the form of a square set at an angle of 45 degrees. Each side of the UN 3373 diamond should measure a minimum of 50 mm (2”). The width of the diamond rule line must be a minimum of 2 mm, and the letters and numbers must be at least 6 mm high.

FedEx UN 3373 Packaging Options

The FedEx UN 3373 Pak, FedEx Medium Clinical Box, and the FedEx Large Clinical Box may not be available in your market; please contact your local customer service team for FedEx supplies.

For your convenience, we offer the FedEx UN 3373 Pak, the FedEx Medium Clinical Box, and the FedEx Large Clinical Box as packaging options for your Biological Substance, Category B (UN 3373) shipments. We recommend the FedEx UN 3373 Pak for use when the sturdy outer packaging of your properly packaged shipment is smaller than 7" x 4" x 2" (minimum acceptable size).

To help increase your operational efficiencies and clearly identify this type of shipment, the FedEx UN 3373 Pak is preprinted with the required IATA UN 3373 marking, the proper shipping name, and the OVERPACK marking. FedEx clinical boxes require the addition of proper IATA UN 3373 markings when used to ship Biological Substance, Category B (UN 3373) shipments. The FedEx UN 3373 Pak can only be used to ship Biological Substance, Category B (UN 3373) shipments. If you need an overwrap for exempt clinical and environmental test sample shipments, use the FedEx® Clinical Pak.

FedEx UN 3373 Pak



FedEx Large Clinical Box, FedEx Medium Clinical Box



Packaging Restrictions

- Plastic bags and paper envelopes are unacceptable outer containers.
- The FedEx[®] Envelope, FedEx[®] Tube, FedEx[®] Pak, FedEx[®] Padded Pak, and FedEx boxes, including FedEx brown packaging offered at FedEx shipping locations, are not acceptable as outer containers for Biological Substance, Category B (UN 3373) shipments.
- The FedEx Clinical Pak cannot be used to ship Biological Substance, Category B (UN 3373) shipments.
- Only shipments classified as Biological Substance, Category B (UN 3373) can be shipped in the FedEx UN 3373 Pak.
- Biological Substance, Category B (UN 3373) shipments that are shipped refrigerated, frozen, on dry ice, or in liquid nitrogen must comply with current IATA and ICAO regulations.

Note: FedEx World Service Center[®] locations do not accept shipments classified as Biological Substance, Category B (UN 3373). Call your local customer service team to schedule a FedEx Express pickup.

The FedEx Medium Clinical Box and the FedEx Large Clinical Box may be used to ship either non-infectious clinical samples or samples classified as Biological

Substance, Category B (UN 3373), but they must be properly labeled. The shipper assumes sole responsibility for compliance with all applicable governmental regulations.

FedEx Packaging Services

FedEx Packaging Services offers package development consultation services. The FedEx Packaging Services lab does not test packaging containing Biological Substance, Category B (UN 3373) materials. For details or to request package development consultation services, please contact your FedEx account executive.

NOTICE:

FedEx Express will refuse to accept packages that do not meet FedEx Express, government, or IATA and ICAO requirements. This brochure is in no way intended to replace requirements mandated by 49 Code of Federal Regulations (49CFR) and IATA. This is for informational purposes only.

NOTICE: This packaging brochure is provided to FedEx customers to help reduce loss or damage due to improper packaging. It is NOT intended to be a comprehensive guide for packaging items we accept for transit. We make no warranties, expressed or implied, regarding this information. Proper packaging is the sole responsibility of the shipper. For more information and comprehensive guidelines, contact your local customer service team. Refer to the current FedEx Standard Conditions of Carriage for terms, conditions, and limitations applicable to your express shipments.
© 2017 FedEx. All rights reserved.



Automotive and Mechanical Parts Packaging Guidelines and Designs

Responsible packaging can save you money and improve the safety and handling of your shipments. Follow these tips and design recommendations.

Contents

General Guidelines	38
Automotive Parts Best Practices	38
Shipping Methods and Minimum Packaging Requirements	38
Shipping in Corrugated Boxes	38
Shipping With Secure Wrapping and Padding	39
Shipping With a Forklifable Base	40
Dangerous Goods/Hazardous Materials Guidelines	40
Packaging Designs for Automotive Parts	40
Packaging Freight Shipments	43
Sealing and Labeling Instructions	44



General Guidelines

- Pad all sharp edges, corners, and burrs of parts such as sheet metal or bare metal.
- Pad or cover precision-machined areas of parts, such as threads and fittings.
- Protect all parts that are susceptible to damage due to dents, scratches, and scuffing by using an appropriate amount of cushioning material and placing in a sturdy shipping container.
- Place documentation and shipping or routing labels on flat surfaces that will allow for maximum adhesion. Avoid placing labels around curved surfaces.
- Place all labels on the side with the largest surface area.
- Use FedEx tie-on tags, tire/crate labels, or plastic air-bill pouches instead of wire tags.

Automotive Parts Best Practices

- Ship engines, motors, transmissions, and chassis parts via FedEx Express[®] services.
- Drain and empty parts filled with lubricant fluids before shipping or demonstrate that the shipment is leakproof under all orientations.
- Help reduce damages and ensure safe working conditions for handlers by adequately packaging all mechanical or automotive parts.

Shipping Methods and Minimum Packaging Requirements

You are responsible for proper packaging when shipping; these tips should be helpful when packaging specific items. If items are not fully encased in an outside shipping container, an additional handling surcharge may apply. For complete terms and conditions, see the current FedEx Service Guide.

FedEx may reject any parts packaging that does not meet the minimum shipping standards for acceptance.

Shipping in Corrugated Boxes

When packaging parts, use adequate dunnage such as foam, loosefill peanuts, or other padding material to fill void spaces and prevent movement inside the box.

Wheels

Cushion the entire surface, and box chrome, painted, and decorative wheels that are susceptible to damage as a result of scratches or scuffing. Wrap non-decorative wheels in adequately taped clear plastic liner.

Flexplates, Flywheels

Pack flexplates and flywheels with adequate dunnage such as loosefill peanuts to fill void spaces in double- or triple-wall corrugated boxes, depending on the weight of the part. Apply “heavy” stickers to boxes exceeding 34 kg (75 lbs).

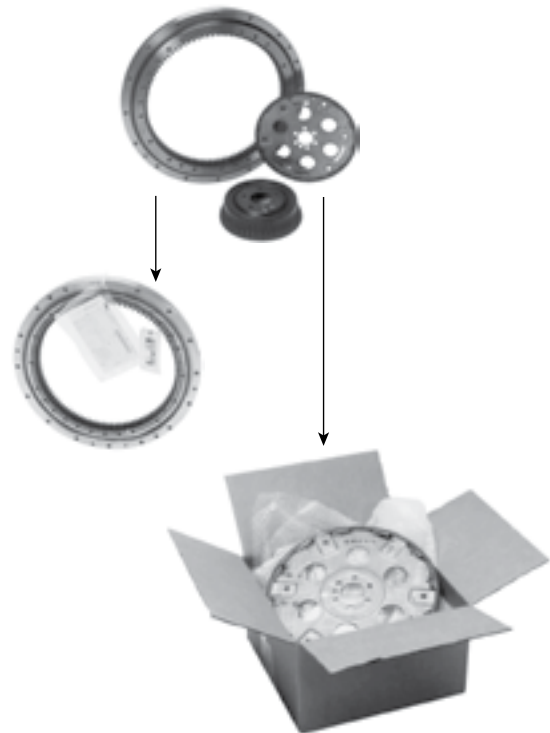

Car Doors, Hoods, Panels

Cushion and box all exposed metallic surfaces that are susceptible to damage as a result of scratches or dents.

Decorative Parts

Cushion and box all decorative parts such as grills that may be unusable as a result of scratches, dents, bending, or scuffing.

Flexible Plastic Moldings

Cushion and box all flexible plastic moldings to prevent breakage or tearing.

Pad and cover protruding parts that might break or puncture the box.

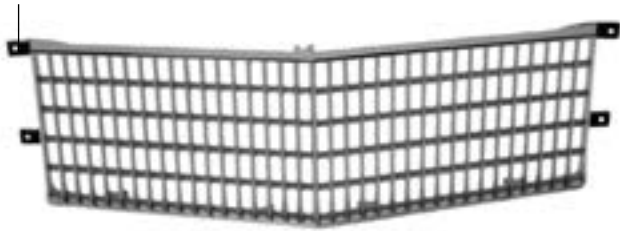

Shocks, Coil Springs

Box cylindrical parts that can be packaged in tubes with adequate dunnage such as padding at the ends and loosefill peanuts to prevent puncturing through the end closures. Tag coil springs with a FedEx non-conveyable tie-on tag and adhere the shipping label to the tie-on tag if the item cannot be packaged in a tube or corrugated box.

Bumpers

Box bumpers that are susceptible to scratches or dents. Or wrap bumpers in adequately taped heavy-duty plastic bags and padding to protect any sharp or pointed corners.

Shipping With Secure Wrapping and Padding

When preparing irregular-shaped parts for shipment, tape cushioning material securely to help prevent removal during the handling process. We recommend placing the parts in a box in addition to the minimum requirements shown.

Moldings

Wrap non-decorative plastic moldings in adequately taped plastic film or bags, or cushion and box them.

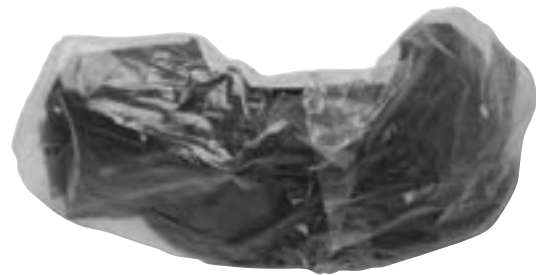

Sway Bars, A-Arms

Wrap sway bars, A-arms, and threaded rods in fiberboard or appropriate plastic film or bags and tape securely.

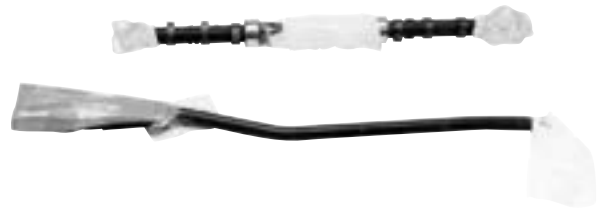

Exhaust System Parts, Leaf Springs

Pad and cover pointed and sharp edges with corrugated boards, adequate foam, or air-cellular cushioning material such as Bubble Wrap[®] and tape securely.



Tires

Place the tire/crate label on the tread of the tire and apply the FedEx shipping label on top of the tire/crate label.



Shipping With a Forkliftable Base

Secure transmissions and other parts weighing more than 68 kg (150 lbs.) to a forkliftable base compatible with pallet-jack usage. Banding to a pallet or bracing inside a corrugated container helps prevent damage in handling. For information on shipping freight, see the “Packaging Freight Shipments” section.

Transmissions, Engines

Drain the transmission of all fluids and place it in a plastic bag with absorbent padding below to absorb any residual fluid. When using expendable packaging, securely band it to its pallet, or block or brace it inside its corrugated container. If you use a reusable container, secure the transmission to the base with strapping.

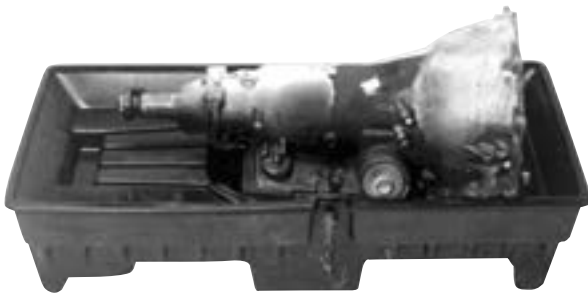

Dangerous Goods/Hazardous Materials Guidelines

Some of the most frequently shipped automotive and mechanical parts and accessories may be considered dangerous goods and hazardous materials. These include air-bags, aerosols (some examples include paint and lubricants), batteries, engines and engine blocks with hazardous fuel, used fuel tanks, flammable paints, and touch-up paints.

Check with the manufacturer for the Material Safety Data Sheet (MSDS) for detailed information on the product. The shipper is responsible for correctly identifying, classifying, packaging, marking, labeling, and completing documentation for dangerous goods and hazardous materials. The IATA/ICAO regulations require shippers to have job-specific dangerous goods training prior to tendering dangerous goods to FedEx or another air carrier. Reference the current IATA or ICAO regulations for complete details.

FedEx Express is required by law to report improperly declared or undeclared shipments of dangerous goods to the U.S. Department of Transportation (DOT) and the local competent authority. The shipper may be subject to fines and penalties under applicable law. Questions may be directed to your local customer service team.

Packaging Designs for Automotive Parts

At FedEx we know packaging, and we're available to help you design automotive packaging that protects your parts. We may even help you save money with packaging that weighs less and is easier to make than your current designs.

Our FedEx package-design engineers develop packaging for parts every day. Most designs use cost-effective corrugated cushioning material and molded components to help prevent damage during transit. Best of all, each design passes FedEx test procedures and is available for you to use.

Our team offers consultation services, specifications, and computer-aided design (CAD) drawings to assist your packaging producer with development of your mechanical and automotive packaging.

(This service may not be available in your market.)

Here are just a few of our designs.

Flat-Style Hood Design

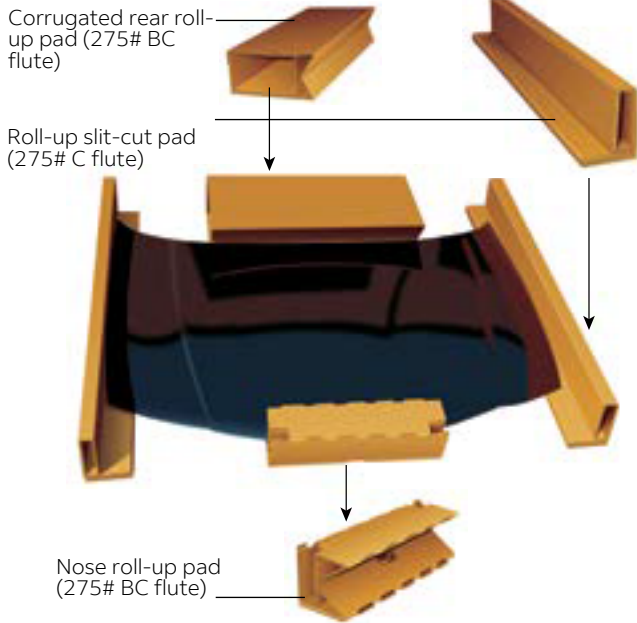

With this design, you center the nose and rear roll-up pads and staple them to the inner flaps of the end-loaded full-overlap shipping container. Place the hood in the container followed by roll-up slit-cut pads. Close and tape.

Hood and cushioning are placed inside a 275# BC flute full-overlap corrugated shipping container before shipping.

Grill-Style Hood Design

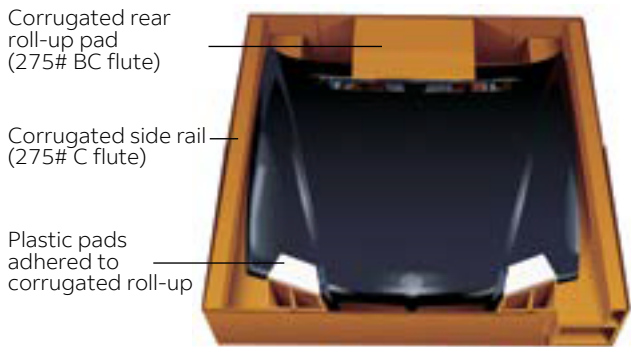

This design incorporates side rails to elevate and suspend the hood. The air space created by the elevation helps protect the grill from external forces.

Before shipping, place the hood and cushioning inside a 275# BC flute full-telescope corrugated shipping container for protection and stability.

Overbox-Style Hood Design

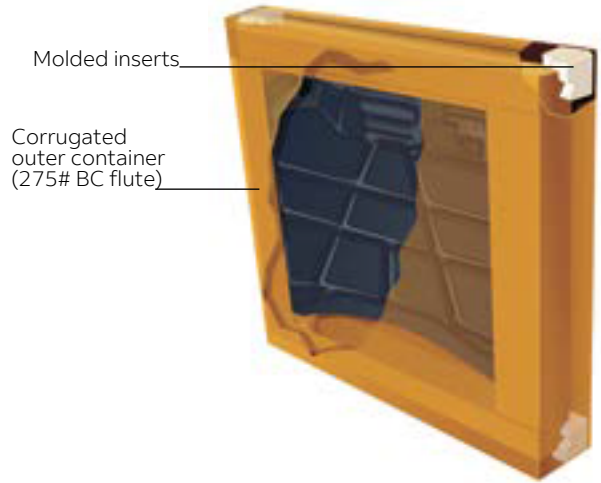

This design uses molded pulp inserts on all four class A sides of the inner container to help provide cushioning.

Before shipping, place the hood and cushioning inside a 275# BC flute corrugated shipping container for support and protection.

Trunk-Pack Design

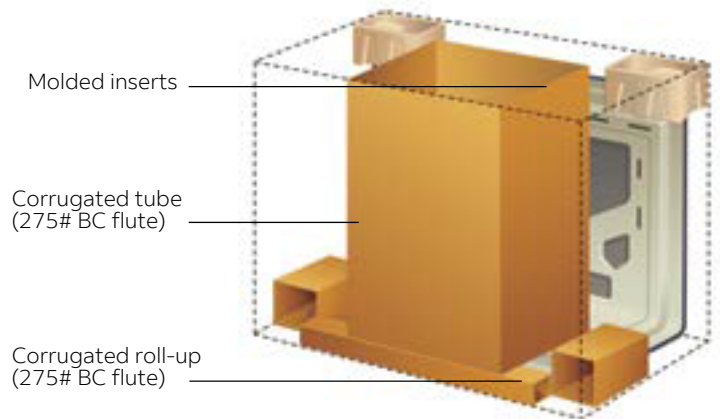

This design helps protect the trunk pack from external forces. Molded inserts are used to create air cells and brace the trunk lid.

Once the inserts are in place, place both the trunk lid and cushioning inside a 275# BC flute full-overlap corrugated shipping container for protection.

Door-Pack Design

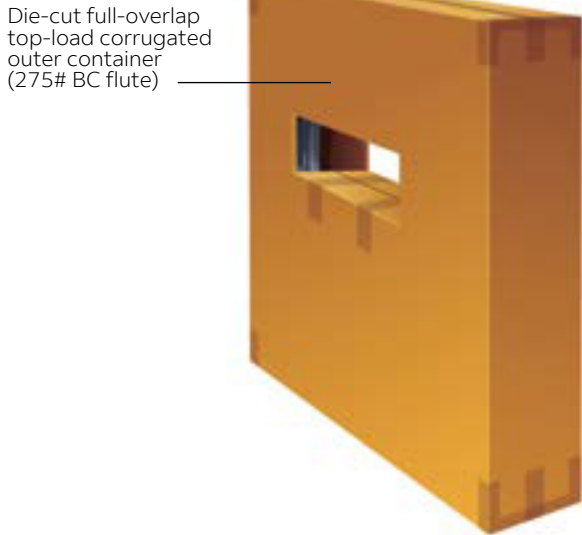
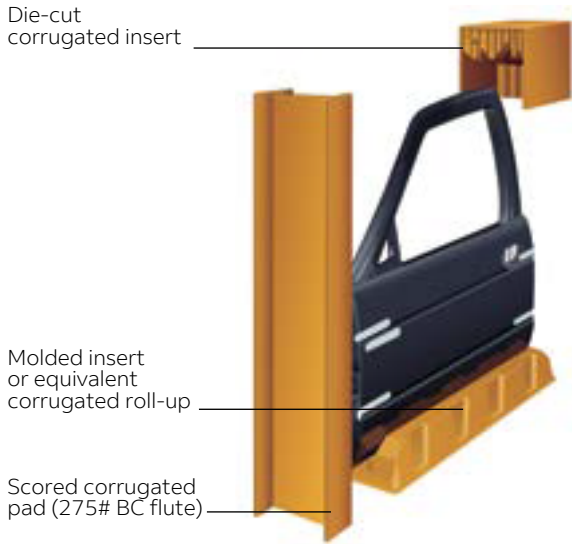

This design combines the use of a scored pad, a die-cut corrugated insert, and a molded insert to help provide cushioning and bracing of the door inside the outer shipping container.

Once roll-ups and pads are attached to the door, place both the door and cushioning inside a 275# BC flute corrugated shipping container for protection.

Windshield-Pack Design

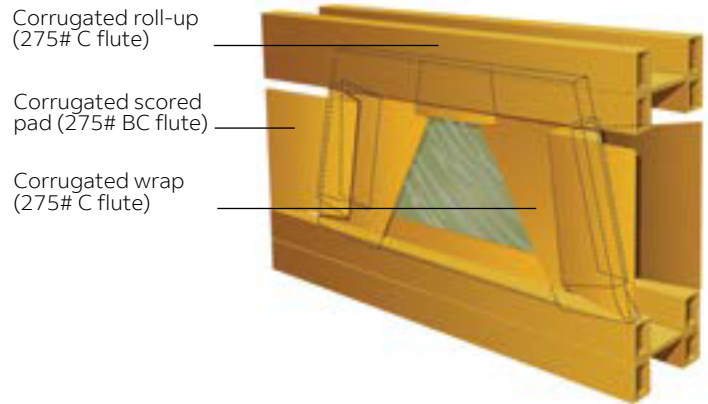

This design helps protect windshields from shock and/or torque during transit. The wrap converts a non-rigid part into a rigid surface so it can be cushioned and braced off of the corrugated wrap.

Before shipment, place the windshield and cushioning inside a full-overlap 275# BC flute corrugated shipping container.

Rim-Pack Design

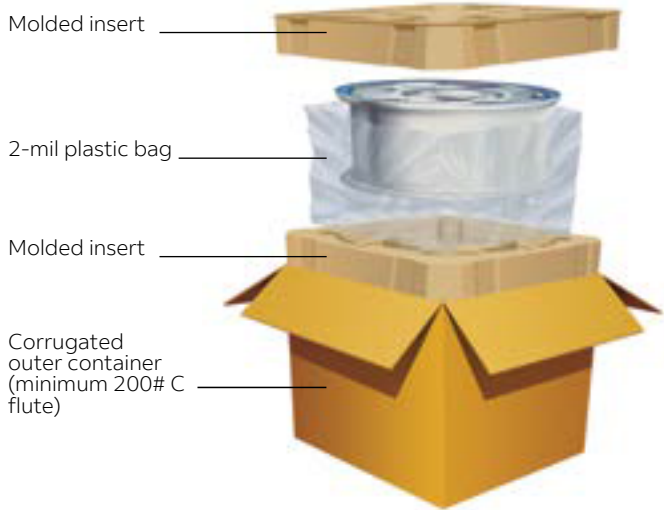

This design protects the rim from dents, scratches, and abrasions. The molded inserts are designed to fit multiple sizes.

Fascia- (Bumper Cover) Pack Design

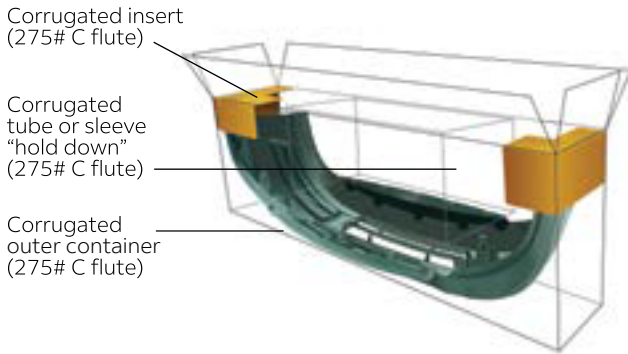

This design protects the fascia from scratches and abrasions. Additional poly-bag surface protection is optional.

Before shipping, place the fascia inside a 275# C flute corrugated full-overlap shipping container. Then place inserts and the tube or sleeve into position.

Trim or Molding Pack Design

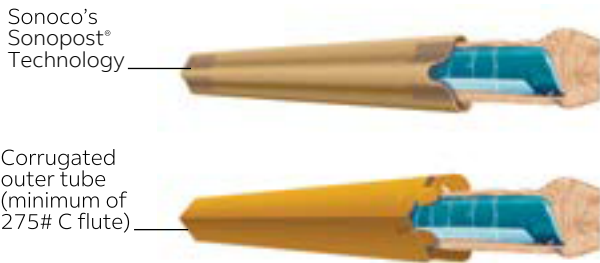

This rigid outer package design protects the pre-paint trim or moldings from scratches and bending.

Trim Sonopost to fit the part length. Insert the covered trim or molding into the corrugated outer container, and tape both ends with minimum 5-cm- (2") wide pressure-sensitive plastic tape.

Packaging Freight Shipments

Shipments that qualify as freight must be packaged accordingly. See the current FedEx Service Guide to determine if your shipment qualifies as freight.

You must package your freight shipments to allow for stacking of other packages on top of your shipment. Make sure your freight shipments are banded and stretchwrapped to the pallet, with the bands running in both directions. (Pallet loads secured with only stretchwrap are not acceptable.)

Avoid corrugated or fiberboard pallets. You must secure all freight shipments weighing 68 kg (151 lbs.) or more on a forkliftable base, compatible with pallet-jack usage. The minimum specifications for a typical base for forklift or pallet-jack configuration are illustrated here.

Express Freight Shipments

To lessen the possibility of damage or delay to your cargo, make sure that all single-piece cargo greater than 68 kg (150 lbs.) is banded on all sides with heavy-duty metal or break-resistant plastic banding.

If your cargo is a single piece contained within a hard container (plywood, metal) and is greater than 68 kg (150 lbs.), it does not require banding if exterior locks or clamps are used. (Glue, nails, or screws are not sufficient.)

Minimum Freight Specifications, Typical Base, Forklift or Pallet-Jack Configuration

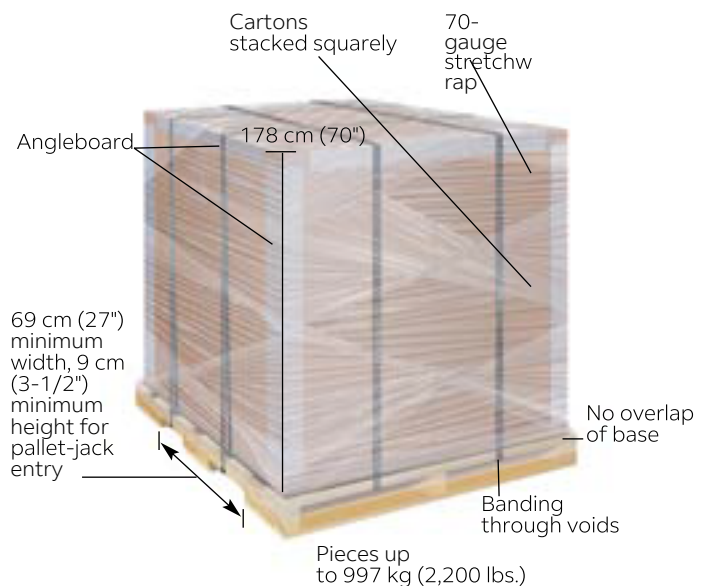

Sealing and Labeling Instructions

- When sealing corrugated outer containers, apply at least three strips of pressure-sensitive adhesive plastic tape that is at least 5 cm (2") wide to both the top and bottom of the carton.
- Tape all seams or flaps using the H taping method.
- Place the shipping label on the top of the largest side.
- When shipping parts that cannot be packaged in corrugated outer containers, tag them appropriately.
- Tag wrapped and padded parts with a FedEx non-conveyable tie-on tag and adhere the shipping label to the tie-on tag.
- Request tie-on tags, cable ties, or tire/crate labels at [fedex.com](https://www.fedex.com) or call your local customer service team. You may also contact your account executive for supplies.

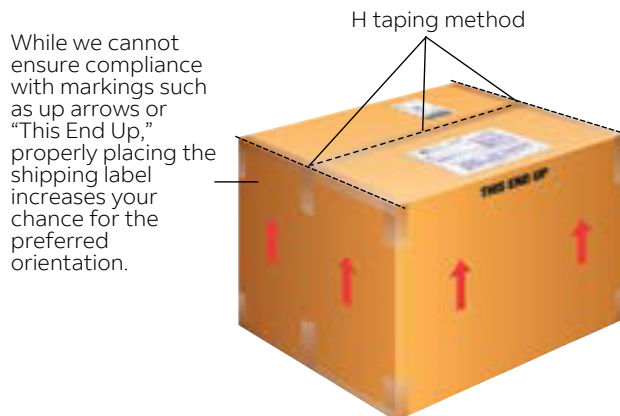

Bubble Wrap is a registered trademark of Sealed Air Corporation. Sonopost is a registered trademark of Sonoco Products Company.

NOTICE: This packaging brochure is provided to FedEx customers to help reduce loss or damage due to improper packaging. It is NOT intended to be a comprehensive guide for packaging items we accept for transit. We make no warranties, expressed or implied, regarding this information. Proper packaging is the sole responsibility of the shipper. For more information and additional guidelines, go to the packaging tips page on [fedex.com](https://www.fedex.com) or contact your local customer service team. Refer to the current FedEx Standard Conditions of Carriage for terms, conditions, and limitations applicable to your express shipments.

© 2017 FedEx. All rights reserved.

Packaging Battery Shipments

Follow these instructions to help ensure safe transportation of your battery shipments and your shipments with items containing batteries within the FedEx Express[®] network.

Contents

Unique Risks Associated With Shipping Batteries	46
Preparing Charged Batteries for Shipment	46
Shipping Wet Batteries	46
Shipping Dry Batteries	46
Shipping Lithium Batteries	47
Sealing and Labeling Instructions	48
Battery Shipment Restrictions and Regulations	49
FedEx Packaging Services	49
Contacts and Resources	49



Unique Risks Associated With Shipping Batteries

Batteries provide the power source for personal computers, phones, automobiles, and life-saving appliances. However, batteries are classified as dangerous goods, because by definition they produce electricity from a chemical reaction. When improperly handled, packaged, or stored, batteries pose a risk for corrosive chemical and electrical fires. Emphasis must be placed on safety when packaging and transporting them. Following is an overview of the requirements for acceptance and transport of batteries using FedEx Express services.

Preparing Charged Batteries for Shipment

At FedEx Express, we understand the importance of ensuring the safe transport of your shipments. Charged battery shipments or shipments with items that contain charged batteries may overheat and ignite in certain conditions and, once ignited, may be difficult to extinguish or may expend corrosive substances.

By following these guidelines and complying with all applicable local, state, and federal laws governing packing, marking, and labeling, you can do your part to help ensure your shipments arrive safely and on time to their final destinations. FedEx Express strictly adheres to International Air Transport Association (IATA) and International Civil Aviation Organization (ICAO) regulations.

FedEx Express limits the shipment of Hoverboards and other self-balancing powered vehicles to those from commercial manufacturers/shippers in original unopened packaging offered as UN 3171, "Battery Powered Vehicle" as a fully regulated dangerous good.

Shipping Wet Batteries

Wet batteries or wet-cell batteries are typically filled with corrosive acid or alkali and are regulated battery shipments (Class 8 — Corrosive). Wet batteries are common in vehicles, utility systems, un-interruptible power systems, and industrial machinery. These commodities must be correctly identified, classified, packaged, marked, and labeled. Additionally, the package must have the Shipper's Declaration for Dangerous Goods completed and signed by a trained shipper.

UN Numbers and Proper Shipping Names for Wet Batteries

- UN 2794: Batteries, wet, filled with acid (electric storage)
- UN 2795: Batteries, wet, filled with alkali (electric storage)
- UN 2800: Batteries, wet, non-spillable (electric storage)

General Wet-Battery Packaging Guidelines

- Package wet cell batteries in containers, including metal containers, with acid/alkali leakproof liner — sealed to prevent leakage.
- Fasten batteries securely with fill opening and vents facing up to prevent short-circuiting or overheating.
- Position multiple batteries side by side, separated by nonconductive dividers.
- Place contents in a sturdy outer container.

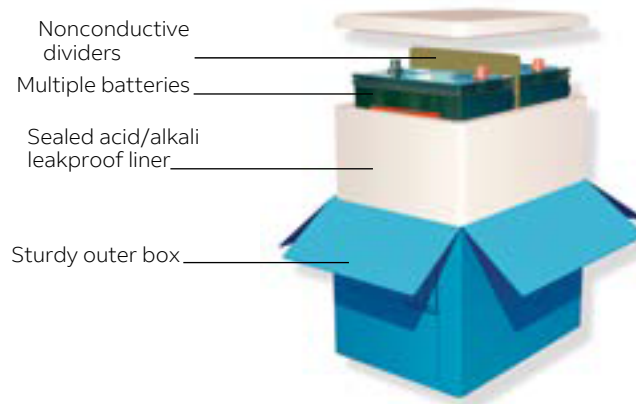

Shipping Non-spillable Wet Batteries

In accordance with 49 Code of Federal Regulations (49CFR) §173.159 and USG-11, an IATA (USG-11) non-spillable wet electric storage battery may be regarded as not subject to the regulations if the battery and its outer packaging are plainly and durably marked "NON-SPILLABLE" or "NON-SPILLABLE BATTERY." The battery must also meet the conditions for being regarded as not subject to the regulations as prescribed in Special Provision A67, meaning that no shipper's declaration is required.

Shipping Dry Batteries

Dry batteries are sealed, nonvented batteries used in flash-lights or small appliances. They contain zinc salts and other solids or may be packed in combination with other metals.

These batteries include non-rechargeable alkaline batteries and rechargeable batteries made with nickel metal hydride and nickel cadmium. Some dry batteries are regulated battery shipments (Class 4 — Dangerous When Wet or Class 8 — Corrosive) and must be correctly identified, classified, packaged, marked, and labeled.

UN Numbers and Proper Shipping Names for Dry Batteries

- UN 3028: Batteries, dry, containing potassium hydroxide, solid (electric storage)
- UN 3292: Batteries, containing sodium

General Dry-Battery Packaging Guidelines

- Position multiple batteries or packages of batteries side by side, separated by dividers.
- Make sure batteries contained in an electronic device remain inside the device when shipping.
- Pack securely and fill void spaces to prevent shifting or movement in transit.
- Place contents in a sturdy outer container.

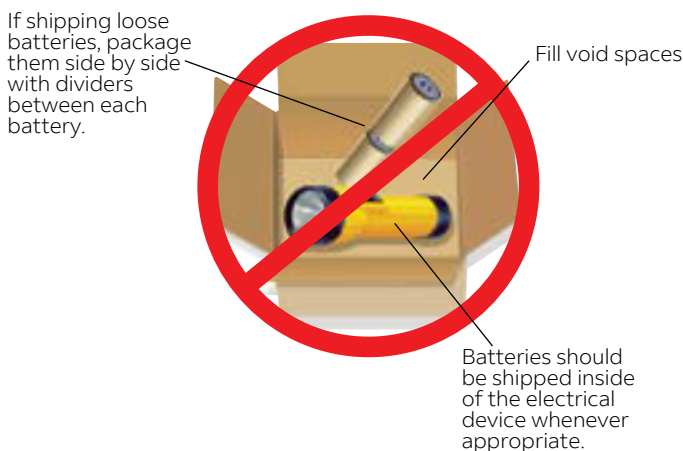
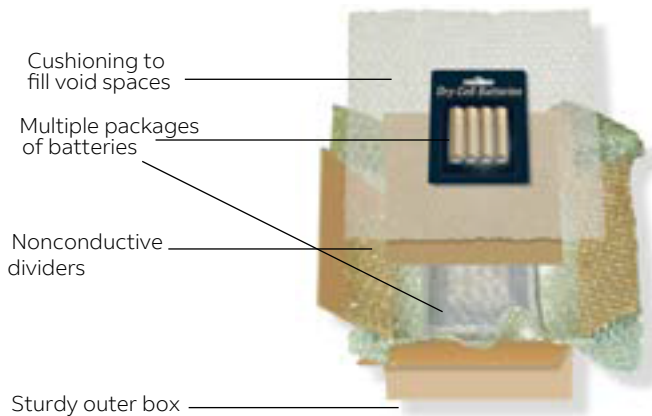

Shipping Lithium Batteries

Lithium batteries are commonly used in devices like mobile phones, laptops, PDAs, watches, cameras, and even children's toys. Lithium battery shipments or shipments with items that contain charged batteries may overheat and ignite in certain conditions and, once ignited, may be difficult to extinguish. The two main types of lithium batteries are lithium metal (primary non-rechargeable) and lithium ion (rechargeable).

UN Numbers and Proper Shipping Names for Lithium Batteries

- UN 3480: Lithium ion batteries
- UN 3481: Lithium ion batteries contained in equipment
- UN 3481: Lithium ion batteries packed with equipment
- UN 3090: Lithium metal batteries
- UN 3091: Lithium metal batteries contained in equipment
- UN 3091: Lithium metal batteries packed with equipment

Lithium metal batteries (primary non-rechargeable), UN 3090 prepared in accordance with Section IA and Section IB of IATA packaging instruction 968 require approval prior to shipping by FedEx Express (operator variation FX-05). Go to fedex.com and enter "lithium batteries" in the search field to learn about the approval process. FedEx Express will not accept lithium battery shipments containing or overpacked with items identified as Class or Division 1, 2.1, 2.2 (if CAO), 3, 4, 5, and 8, whether primary or subsidiary risk.

Section II IATA Lithium Battery Shipments

All packages containing lithium batteries are classified as Class 9 – Miscellaneous Dangerous Goods. However, packages containing small amounts of lithium may be exempted from most of the IATA and ICAO requirements if they comply with the requirements in Section II IATA Packing Instructions (PI) 966, and 967 for lithium ion batteries and 969, and 970 for lithium metal batteries as appropriate.

Beginning January 1, 2017 FedEx Express will not accept UN 3090 or UN 3480 offered as Section II for transit per FedEx Express operator variation FX-05.

Shipments of lithium metal batteries packed with equipment, and lithium metal batteries contained in equipment accepted by FedEx Express may be packaged in accordance with Section II IATA packaging requirements provided that the

lithium content in the cells do not exceed 1g, or the lithium content in the batteries do not exceed 2 g.

Shipments of lithium ion batteries, lithium ion batteries packed with equipment and lithium ion batteries contained in equipment may be packaged in accordance with Section II IATA (Section II ICAO) packaging requirements provided that the metal or alloy cell content does not exceed more than 1g, and the aggregate lithium content does not exceed 2g per battery.

Shipments of lithium ion batteries packed with equipment and lithium ion batteries contained in equipment accepted at FedEx Express must meet the general requirements of the packaging instruction.

Each of the proper shipping names defined in Section II IATA may have additional requirements related to types of approved outer packaging, weight limits, and package drop tests of 1.2m.

When the Lithium Battery Mark (IATA Figure 7.1.C) is required and used for Section IB and permitted Section II lithium battery shipments, the UN number(s) must be added to the mark. Effective July 1, 2017: When the Lithium Battery Handling Label (Figure 7.4.H) is applied to packages/overpacks for Section IB and permitted Section II lithium battery shipments, the applicable UN number(s) must be marked on the package adjacent to the lithium battery handling label. [FX-05]

UN 3480, Lithium Ion Batteries Section IA and IB have a state of charge (SoC) maximum of 30% without competent authority approval from both the state of origin and the state of the operator.

Section II Lithium Battery Packaging Guidelines

To comply with Section II IATA shipping requirements for lithium batteries accepted by FedEx Express, shipments must comply with specific packaging guidelines.

- Ensure that lithium batteries are individually packaged in fully enclosed inner packaging such as a plastic blister wrap or pasteboard to provide protection for each battery.
- Shield and protect lithium batteries to prevent short circuits or contact with conductive materials within the packaging that could cause short circuits.
- Ensure that packaging is proven (i.e., tested) to meet the requirements of each test in the UN Manual of Tests and Criteria, Part III, Sub-Section 38.3.
- Make sure lithium batteries are completely enclosed (such as in equipment or surrounded by plastic with void space

filled to prevent movement), except when the proper shipping names end with “contained in equipment.”

- Place contents in a sturdy outer container.
- Provide correct labeling and documentation.

Certain fully regulated Section IA and Section I Packing Instructions require UN specification packaging that meets Packing Group II performance standards. Refer to the specific IATA Packing Instruction for complete packaging requirements.

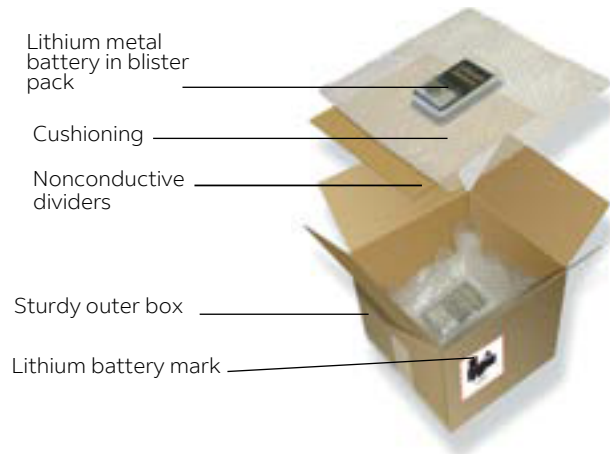

Refer to the FedEx Express lithium battery flow chart for additional assistance at the following url:

<http://images.fedex.com/downloads/shared/packagingtips/lithiumbatteryFlowChart.pdf>

When shipping UN 3480, Lithium Ion Batteries or UN 3090 Lithium Metal Batteries internationally, additional carrier and country limitations apply. Refer to this job aid for country limitations:

http://images.fedex.com/us/services/pdf/LithiumBatteries_Limitations.pdf

Please contact your local Customer Service team for any questions.

Section IA IATA Lithium Battery Shipments

Lithium batteries, both lithium ion and lithium metal, are fully regulated dangerous goods when prepared under Section IA IATA regulations. These commodities must be correctly identified, classified, packaged, marked, and labeled. Additionally, the package must have the Shipper's Declaration for Dangerous Goods completed and signed by a trained shipper.

Section IB IATA Stand-Alone Lithium Battery Shipments

Section IB requirements apply to lithium metal cells with a lithium metal content not exceeding 1 g and lithium metal batteries with a lithium metal content not exceeding 2 g packed per Table 968-IB. Section IB requirements apply to lithium ion cells with a 20 Wh and batteries of 100 Wh or less per Table 965-IB. "IB" is required on the shipper's declaration after Packing Instruction.

See the applicable Packing Instruction for complete details. All IB shipments are required to have a Shipper's Declaration for Dangerous Goods, and "IB" must be indicated either after Packing Instruction number or in Authorization.

When the Lithium Battery Mark (IATA Figure 7.1.C) is required and used for Section IB and permitted Section II lithium battery shipments, the UN number(s) must be added to the mark. Effective July 1, 2017: When the Lithium Battery Handling Label (Figure 7.4.H) is applied to packages/overpacks for Section IB and permitted Section II lithium battery shipments, the applicable UN number(s) must be marked on the package adjacent to the lithium battery handling label. [FX-05]



Sealing and Labeling Instructions

Although these instructions are not regulatory requirements, they represent FedEx best practices when shipping with corrugated boxes.

- Using the H taping method, apply at least three strips of pressure-sensitive adhesive plastic tape that is at least 5 cm (2") wide to both the top and bottom of the carton.
- Tape all seams or flaps.
- Place the shipping label on the top of the largest side.
- Ensure that all required outer markings, labelings, and documentation appear.



Battery Shipment Restrictions and Regulations

FedEx Express will not accept or ship:

- Recalled or defective batteries, either as a stand-alone unit or contained with equipment.
- Recalled or defective lithium batteries contained in electronic equipment, such as a laptop.
- Waste batteries or batteries being shipped for recycling or disposal period.

FedEx World Service Center[®] locations do not accept regulated battery shipments, with the exception of lithium battery shipments meeting Section II IATA regulations.

FedEx Packaging Services

FedEx Packaging Services offers package development consultation services. The FedEx Packaging Services lab does not test packaging containing items classified as dangerous goods. For details or to request package development consultation services, please contact your FedEx account executive.

Contacts and Resources

For more information, please call your local customer service team or go to fedex.com.

Australia	13 26 10
China	800 988 1888 (toll-free) 400 886 1888 (for mobile phone users)
Hong Kong	852 2730 3333
Indonesia	1500342
Japan	0120 003200
Korea	1588-0588
Macau	853 2870 3333
Malaysia	1800 88 6363
New Zealand	0800 733 339
Philippines	1800.10.46.33339 (PLDT, Sun, Smart Subscribers) 1800.8.46.33339 (Globe Subscribers) 045.4993900 (Other Network Subscribers)
Singapore	(Other Network Subscribers)
Taiwan	1800 743 2626
Thailand	0800 075 075 1782 (Bangkok Hotline) 662-491-2000
Vietnam	(International / Non- Thailand line) 1-800 58 58 35 (Toll-Free Line) 84-8-39480 370 (Non-Toll- Free line)

NOTICE: FedEx Express will refuse to accept packages that do not meet FedEx Express, government, or IATA and ICAO requirements.

This brochure is in no way intended to replace requirements mandated by IATA/ICAO or local country or territories regulation. This is for informational purposes only. This packaging brochure is provided to FedEx customers to help reduce loss or damage due to improper packaging. It is NOT intended to be a comprehensive guide for packaging items we accept for transit. We make no warranties, expressed or implied, regarding this information. Proper packaging is the sole responsibility of the shipper. For more information and additional guidelines, go the packaging tips page on fedex.com or contact your local customer service team. Refer to the current FedEx Standard Conditions of Carriage for terms, conditions, and limitations applicable to your express shipments.